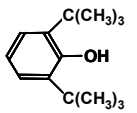
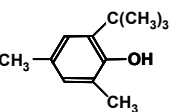
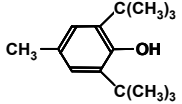
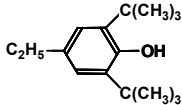
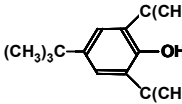
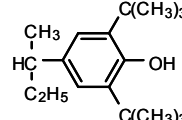
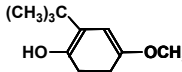
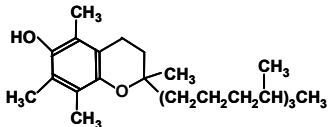
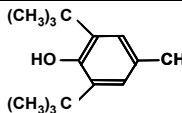

Additive Library List

ID	Type
A	Antioxidant
B	Ultraviolet absorber, Light stabilizer
C	Metal deactivator
D	Stabilizer
G	Lubricant
H	Plasticizer
I	Antistatic additive
J	Anti-clouding agents
K	Fire retardant
L	Blowing agent
N	Conductive agent
O	Nucleating agent
P	Optical characteristic controlling agent
Q	Antibacterial, Antifungal agent
R	Resin modifier
V	Vulcanization accelerator
W	Antidegradant

Entry ID	Name	Synonyms	MW (Exact Mass)	Compositional formula	Structure Formula	TIC at 400°C Included	Newly added in 16B Lib
A(1)-001	2,6-Di- <i>t</i> -butylphenol	Ethyl 701(Ethyl Corp.), Ionox 99(Shell)	206.17	C ₁₄ H ₂₂ O		-	-
A(1)-002	2,4-Dimethyl-6- <i>t</i> -butylphenol	Antioxidant No 30(Du Pont), Topanol A(ICI)	178.14	C ₁₂ H ₁₈ O		-	-

A(1)-003	2,6-Di- <i>t</i> -butyl-4-methylphenol, Butyl hydroxy toluene	Sumilizer BHT(Sumitomo Chemical), Yoshinox BHT(Mitsubishi Pharma), Antage BHT(Kawaguchi Chemical Industrial), Nocrak 200(Ouchishinko Chemical Industrial), Ionol(Shell), VullanoxKB(Bayer)	220.18	C15H24O		-	-
A(1)-004	2,6-Di- <i>t</i> -butyl-4-ethylphenol	Yoshinox 250(Mitsubishi Pharma), Nocrak M-17(Ouchishinko chemical Industrial)	234.20	C16H26O		-	-
A(1)-005	2,4,6-Tri- <i>t</i> -butylphenol	Antioxidant Hoechst TMOZ(Hoechst)	262.23	C18H30O		-	-
A(1)-006	2,6-Di- <i>tert</i> -butyl-4- <i>sec</i> -butylphenol	-	262.23	C18H30O		-	✓
A(1)-020	Butyl hydroxyanisole, 2- <i>t</i> -Butyl-4-methoxyphenol	Orient BHA(Orient Chemical Industries)	180.11	C11H16O2		-	-
A(1)-021	Tocopherol, Vitamin E	Vitamin E(Eisai), Riken E-oil 700(Riken Vitamin)	430.71	C29H50O2		-	-
A(1)-030	2,6-Di- <i>t</i> -butyl-4-hydroxymethylphenol	Ionox 100(Shell)	236.18	C15H24O2		-	-

A(1)-040	<i>n</i> -Octadecyl-3-(4-hydroxy-3',5'-di- <i>tert</i> -butylphenyl)propionate	Irganox 1076(Ciba-Geigy), Sumilizer BP-76(Sumitomo Chemical), ADK STAB AO50(Adeka), Tominox SS(Mitsubishi Pharma), Etanox 376(Ethyl Corp.)	530.47	C35H62O3		-	-
A(1)-045	2-[1-(2-hydroxy-3,5-di- <i>t</i> -pentylphenyl)ethyl]-4,6-di- <i>t</i> -pentylphenyl acrylate	Sumilizer-GS(Sumitomo Chemical)	548.84	C37H56O3		-	-
A(1)-050	2,6-Di- <i>t</i> -butyl-4-(<i>N,N</i> -dimethylaminomethyl)phenol	Ethanox 703(Ethyl Corp.)	263.22	C17H29ON		-	-
A(1)-060	3,5-Di- <i>t</i> -butyl-4-hydroxybenzylphosphonate-diethylester	Irganox 1222(Ciba-Geigy)	356.21	C19H33O4P		-	-
A(1)-070	6-[3-(3- <i>t</i> -butyl-4-hydroxy-5-methylphenyl)propoxy]-2,4,8,10-tetra- <i>t</i> -butyldibenzo[d,f][1,3,2]dioxaphosphepin	Sumilizer-GP(Sumitomo Chemical)	660.91	C42H61O4P		-	-
A(1)-090	4,6-Bis(octylthiomethyl)- <i>o</i> -cresol	Cable KV-10(Ciba-Geigy)	424.75	C25H44OS2		✓	-
A(1)-120	Propyl gallate	Plogaline P(Nipa Laboratories)	212.07	C10H12O5		-	-

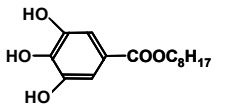
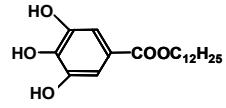
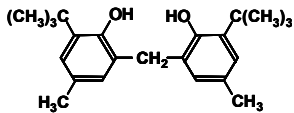
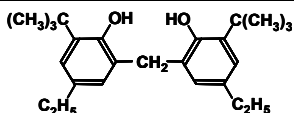
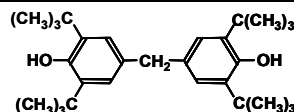
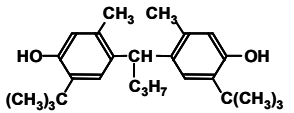
A(1)-121	Octyl gallate	Plogaline O(Nipa Laboratories)	282.15	C ₁₅ H ₂₂ O ₅		-	-
A(1)-122	Lauryl gallate	Plogaline LA(Nipa Laboratories)	338.21	C ₁₉ H ₃₀ O ₅		-	-
A(1)-200	2,2'-Methylenebis(4-methyl-6- <i>t</i> -butylphenol)	Yoshinox 226G(Mitsubishi Pharma), Seenox 224M(Shipro Kasei Kaisha), Cyanox 2246(Am. Cyanamid), Sumilizer MDP-S(Sumitomo Chemical)	340.24	C ₂₃ H ₃₂ O ₂		-	-
A(1)-201	2,2'-Methylenebis(4-ethyl-6- <i>t</i> -butylphenol)	Cyanox 425(Am. Cyanamid), Yoshinox 425(Mitsubishi Pharma), Antage W-500(Kawaguchi Chemical Industries), Nocrac NS-5(Ouchishinko Chemical Industrial)	368.55	C ₂₅ H ₃₆ O ₂		-	-
A(1)-202	4,4'-Methylenebis(2,6-di- <i>t</i> -butylphenol)	Seenox 226M(Shipro Kasei Kaisha), Ethanox 702(Ethyl Corp.)	424.66	C ₂₉ H ₄₄ O ₂		-	-
A(1)-221	4,4'-Butylidenebis(3-methyl-6- <i>t</i> -butylphenol)	Santowhite Powder(Monsanto), Sumilizer BBM-S(Sumitomo Chemical), ADK STAB AO40(Adeka), Antage W-300(Kawaguchi Chemical Industrial)	382.58	C ₂₆ H ₃₈ O ₂		-	-

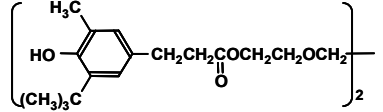
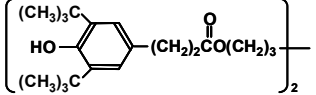
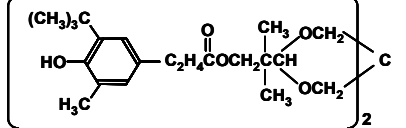
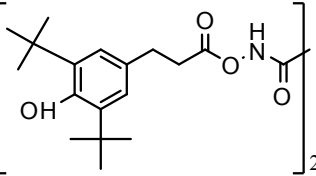
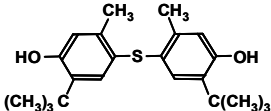
A(1)-240	Triethyleneglycol bis[3-(3- <i>t</i> -butyl-4-hydroxy-5-methylphenyl)propionate]	Irganox 245(Ciba-Geigy), Tominox 917(Mitsubishi Pharma), ADK STAB AO-70(Adeka)	586.76	C34H50O8		-	-
A(1)-241	1,6-Hexanediol bis[3-(3,5-di- <i>t</i> -butyl-4-hydroxyphenyl)propionate]	Irganox 259(Ciba-Geigy)	638.92	C40H62O6		-	-
A(1)-243	3,9-Bis [2-[3-(3- <i>t</i> -butyl-4-hydroxy-5-methylphenyl)propionyloxy]-1,1-dimethylethyl]-2,4,8,10-tetraoxaspiro[5,5]undecane	Sumilizer GA-80(Sumitomo Chemical), ADK STAB AO80(Adeka)	740.96	C43H64O10		✓	-
A(1)-244	N,N'-Bis[2-[2-(3,5-di- <i>t</i> -butyl-4-hydroxyphenyl)ethyl carbonyloxy]ethyl]oxamide	Thanox MD-1060 (Rianlon)	696.43	C40H60N2O8			✓
A(1)-251	4,4'-Thiobis(3-methyl-6- <i>t</i> -butylphenol)	Sumilizer WX-R(Sumitomo Chemical), Yoshinox SR(Mitsubishi Pharma), Nocrak 300(Ouchishinko Chemical Industrial), Santonox R(Monsanto)	358.54	C22H30O2S		-	-

A(1)-253	Bis(3,5-di- <i>t</i> -butyl-4-hydroxybenzyl)sulfide	Sandant 103(Sanshin Chemical Industry)	470.75	C30H46O2S		✓	-
A(1)-255	2,2-Thiodiethylene bis[3-(3,5-di- <i>t</i> -butyl-4-hydroxyphenyl)propionate]	Irganox 1035(Ciba-Geigy), ADK STAB AO-75(Adeka), Anox 70(EniChem)	642.93	C38H58O6S		-	-
A(1)-260	2,4-Bis(n-octylthio)-6-(4'-hydroxy-3,5-di- <i>t</i> -butylanilino)-1,3,5-triazine	Irganox 565(Ciba-Geigy)	588.95	C33H56N4OS2		-	-
A(1)-270	<i>N,N'</i> -Hexamethylene bis(3,5-di- <i>t</i> -butyl-4-hydroxyhydrocinnamide)	Irganox 1098(Ciba-Geigy)	636.95	C40H64N2O4		✓	-
A(1)-271	<i>N,N'</i> -Bis[3-(3,5-di- <i>t</i> -butyl-4-hydroxyphenyl)propionyl] hydrazine	Irganox MD1024(Ciba-Geigy)	552.79	C34H52N2O4		✓	-
A(1)-280	Calcium bis[monoethyl(3,5-di- <i>t</i> -butyl-4-hydroxybenzyl)phosphonate]:Polyethylene wax=50:50	Irganox 1425WL(Blend with Polyethylene wax 50%)(Ciba-Geigy)	690.88	C36H60CaO6P		-	-
A(1)-290	Alkylated bisphenol	Sumilizer NW(Sumitomo Chemical)	-	-	-	-	-

A(1)-300	1,1,3-Tris(2-methyl-4-hydroxy-5- <i>t</i> -butylphenyl)butane	Topanol CA(ICI), ADK STAB AO-30(Adeka), Seanox 336B(Shipro Kasei Kaisha), GHSY-980(Mitsubishi Pharma)	544.81	C37H52O3		-	-
A(1)-301	1,3,5-Trimethyl-2,4,6-tris(3,5-di- <i>t</i> -butyl-4-hydroxybenzyl)benzene	Irganox 1330(Ciba-Geigy), Seanox 326M(Shipro Kasei Kaisha), ADK STAB AO-330(Adeka), Ethanox 330(Ethyl Corp.)	774.59	C54H78O3		-	-
A(1)-310	Tris(3,5-di- <i>t</i> -butyl-4-hydroxyphenyl)isocyanurate	Cheminox 314(Chemipro Kasei Kaisha)	741.47	C45H63N3O6		-	-
A(1)-311	Tris(3,5-di- <i>t</i> -butyl-4-hydroxybenzyl)isocyanurate	Goodlite 3114(Goodrich), Irganox 3114(Ciba-Geigy), ADK STAB AO-20(Adeka), GSY-314(Mitsubishi Pharma), Anox IC-14(EniChem)	784.08	C48H69N3O6		✓	-

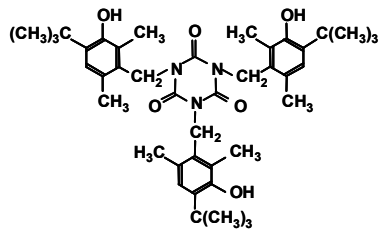
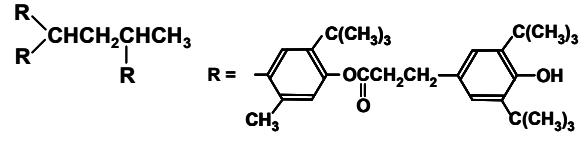
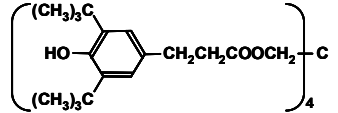
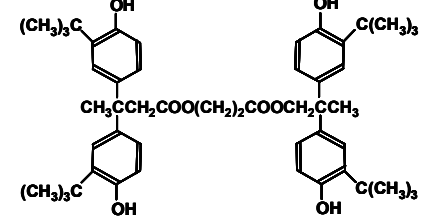
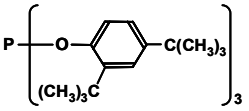
A(1)-312	1,3,5-Tris(4- <i>t</i> -butyl-3-hydroxy-2,6-dimethylbenzyl)isocyanurate	Sumilizer BP-179(Sumitomo Chemical), Cyanox 1790(Am. Cyanamid)	699.42	C42H57N3O6		✓	-
A(1)-322	1,1,3-Tris[2-methyl-4-[3-(3,5-di- <i>tert</i> -butyl-4-hydroxyphenyl)propionyloxy]-5- <i>tert</i> -butylphenyl]butane	Yoshinox GSY-242(Mitsubishi Pharma)	1324.92	C88H124O9		-	-
A(1)-410	Tetrakis[methylene 3-(3',5'-di- <i>t</i> -butyl-4-hydroxyphenyl)propionate]methane	Irganox 1010(Ciba-Geigy), Sumilizer BP-101(Sumitomo Chemical), ADK STAB AO-60(Adeka), Tominox TT(Mitsubishi Pharma), Anox 20(EniChem)	1176.78	C73H108O12		-	-
A(1)-411	3,3-Bis(3- <i>t</i> -butyl-4-hydroxyphenyl)ethyl enebutylate	Hostanox 03(Hoechst)	795.05	C50H66O8		✓	-
A(2)-003	Tris(2,4-di- <i>t</i> -butylphenyl)phosphite	Irgafos 168(Ciba-Geigy), Sumilizer P-16(Sumitomo Chemical), ADK STAB AO-2112(Adeka), JP-650(Johoku Chemica), Alkanox 240(EniChem)	646.45	C42H63O3P		-	-

A(2)-004	Tris(nonylphenyl) phosphite	Sumilizer TNP(Sumitomo Chemical), ADK STAB TNP(Adeka), JP-351(Johoku Chemical), Weston 399(Borg Warner), Chelex TM(Sakai Chemical Industry)	688.50	C45H69O3P		-	-
A(2)-005	Tris(mono- & di-nonylphenyl mixed) phosphite	Mark 329K, Mark 329, TNP-N(Sanko Chemical), Polygard HR(Uniroyal Chem)	814.64 or 940.78	C54H87O3P or C63H105O3P	$\left[\begin{array}{c} \text{C}_9\text{H}_{19} \\ \text{C}_9\text{H}_{19} \end{array} \text{C}_6\text{H}_4\text{O} \right]_n \text{P} \left[\text{O}-\text{C}_6\text{H}_4-\text{C}_9\text{H}_{19} \right]_{3-n} \quad (n=1 \text{ or } 2)$	-	-
A(2)-020	Diphenyl isoctyl phosphite	ADK STAB C(Adeka), JPM-308(Johoku Chemical), ODPP(Sanko Chemical)	346.17	C20H27O3P		-	-
A(2)-021	2,2'-Methylene bis(4,6-di- <i>t</i> -butylphenyl)octylphosphite	ADK STAB HP-10(Adeka)	582.84	C37H59O3P		✓	-
A(2)-022	Diphenyl isodecyl phosphite	Mark 135A(Adeka), JPM-311(Johoku Chemical), Chelex-MD(Sakai Chemical Industry)	374.20	C22H31O3P		-	-
A(2)-023	Diphenyl mono(tridecyl) phosphite	Mark 1013(Adeka), JPM-313(Johoku Chemical)	416.53	C25H37O3P		-	-

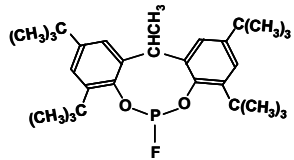
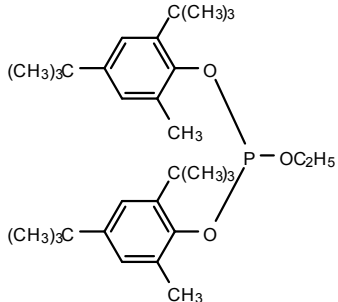
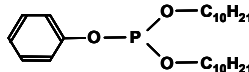
A(2)-024	2,2'-Ethylidenebis(4,6-di- <i>t</i> -butylphenyl) fluorophosphite	Ethanox 398(Ethyl Corp.)	486.64	C30H44FO2P		-	-
A(2)-026	Bis(2,4-di- <i>tert</i> -butyl-6-methylphenyl)ethylphosphite	Irgafos 38(Ciba Specialty)	514.36	C32H51O3P		-	-
A(2)-040	Phenyl di-isodecyl phosphite	Mark 517(Adeka)	438.62	C26H47O3P		-	-
A(2)-060	Tris(2-ethylhexyl) phosphite	JPM-308(Johoku Chemical)	418.36	C24H51O3P	$\text{P} \left(\begin{array}{c} \text{OCH}_2\text{CH}(\text{CH}_2)_3\text{CH}_3 \\ \\ \text{C}_2\text{H}_5 \end{array} \right)_3$	-	-
A(2)-061	Trisisodecyl phosphite	Mark 3010, ADK STAB 3010(Adeka), JP-310(Johoku Chemical)	502.79	C30H63O3P	$\text{P} \left(\text{O C}_{10}\text{H}_{21} \right)_3$	✓	-
A(2)-062	Tris(tridecyl) phosphite	JPS 333E(Johoku Chemical), Mark 3013(Adeka), TTBD-1(Daihachi Chemical Industry)	629.03	C39H81O3P	$\text{P} \left(\text{OC}_{13}\text{H}_{27} \right)_3$	✓	-
A(2)-070	Trilaurylthio phosphite	Weston TLTP(Borg Warner), JPS 312(Johoku Chemical)	635.15	C36H75PS3	$\text{P} \left(\text{SC}_{12}\text{H}_{25} \right)_3$	-	-

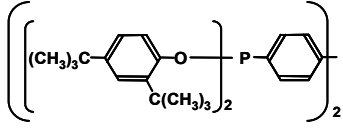
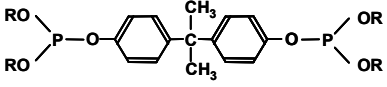
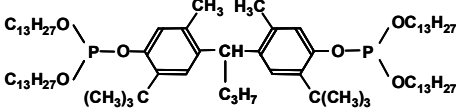
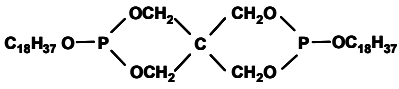
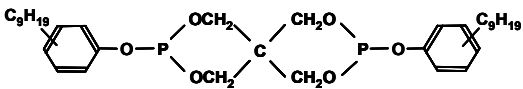
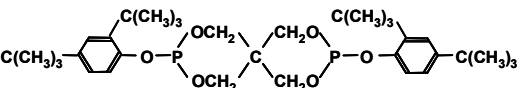
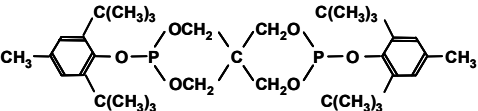
A(2)-080	Tetrakis(2,4-di- <i>t</i> -butylphenyl)-4,4'-biphenylene diphosphonite	Sandstab P-EPQ(Sandoz), Irgafos P-RPQ FF(Ciba-Geigy)	1034.64	C68H92P2O4		-	-
A(2)-085	4,4'-Isopropylidene diphenyl tetraalkyl(C12-C15) diphosphite	Mark 1500, ADK STAB 1500(Adeka), JA-805(Johoku Chemical)	1028.81 - 1196.99	C63H114O6P2 - C75H138O6P2	 (R: C12~C15)	✓	-
A(2)-086	4,4'-Butylidenebis(3-methyl-6- <i>t</i> -butylphenyl)-di-tridecylphosphite	Mark 260, ADK STAB 260(Adeka)	1239.92	C78H144O6P2		-	-
A(2)-090	Distearyl pentaerythritol diphosphite	Mark PEP-8, ADK STAB PEP-8(Adeka), JPP-2000(Johoku Chemical)	733.03	C41H82O6P2		-	-
A(2)-091	Bis(nonylphenyl) pentaerythritol diphosphite	Mark PEP-4C, ADK STAB PEP-4C(Adeka), IPP-31(Johoku Chemical)	632.75	C35H54O6P2		✓	-
A(2)-092	Bis(2,4-di- <i>t</i> -butylphenyl)pentaerythritol diphosphite	ULtranox 626(Borg Warner), ULtranox 624(Borg Warner), ADK STAB PEP-24(Adeka)	604.69	C33H50O6P2		-	-
A(2)-093	Cyclicneopentane tetrayl bis(2,6-di- <i>t</i> -butyl-4-methylphenyl) phosphite	Mark PEP-36, ADK STAB PEP-36(Adeka)	632.75	C35H54O6P2		✓	-

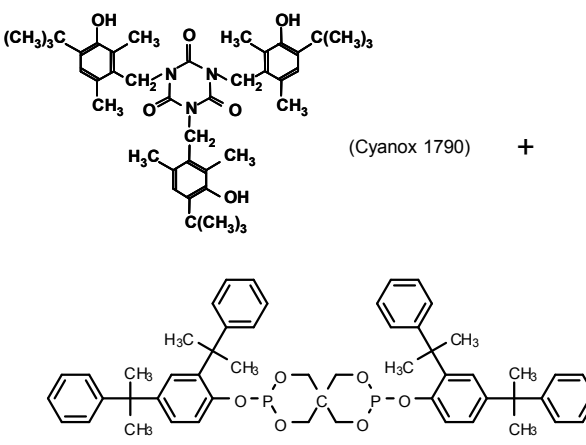
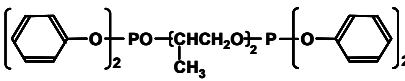
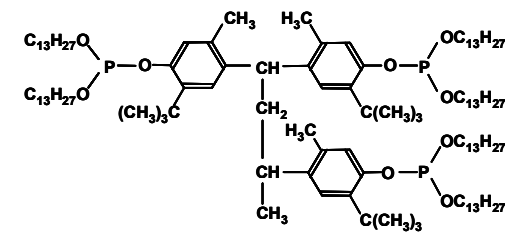
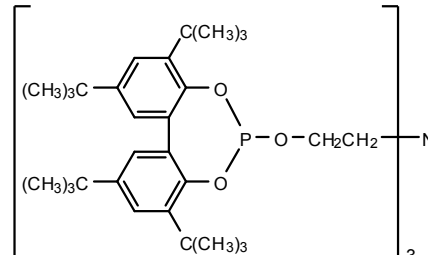
A(2)-096	Mixture of 1,3,5-Tris(4- <i>tert</i> -butyl-3-hydroxy-2,6-dimethylbenzyl)isocyanurate and Bis(2,4-dicumylphenyl)pentaerythritol diphosphite	Cyanox XS4(Cytec)	699.42 852.37	C42H57N3O6 C53H58O6P2	 <p>(Cyanox 1790) +</p>	-	-
A(2)-100	Tetraphenyl dipropylene glycol diphosphite	JPP 100(Johoku Chemical)	566.52	C30H32O7P2		-	-
A(2)-110	1,1,3-Tris(2-methyl-4-di-tridecylphosphite-5- <i>t</i> -butylphenyl)butane	Mark 522A(Adeka)	1830.82	C115H211O9P3		-	-
A(2)-115	2,2',2''-Nitrilo[triethyl-tris[3,3',5,5'-tetra- <i>tert</i> -butyl-1,1'-biphenyl-2,2'-diyl]] phosphite	Irgafos 12(Ciba Specialty)	1463.91	C90H132NO9P3		-	✓

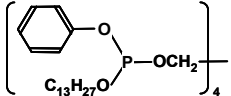
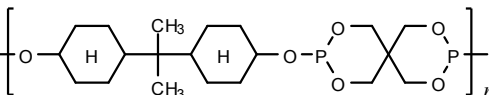
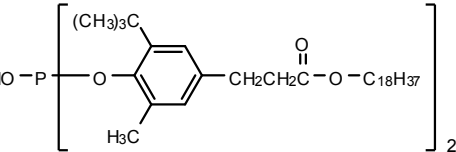
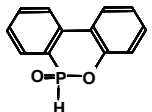
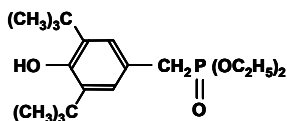
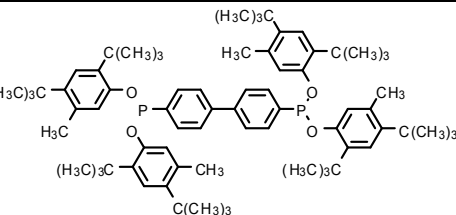
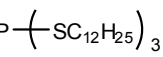
A(2)-120	Tetraphenyl tetra(tridecyl)pentaerythritol tetraphosphite	JPP 613M(Johoku Chemical)	1425.83	C81H136O12P4		-	-
A(2)-130	Hydrogenated bisphenol A - Pentaerythritol phosphite	JPH-3800(Johoku Chemical)	2400 - 3000	(C20H34O6P2) _n		-	✓
A(2)-154	Bis[(2-tert-butyl-6-methyl-4-[2-(octadecyloxy)ethyl]phenyl]hydrogenphosphite	-	1022.80	C64H111O7P		-	✓
A(2)-200	3,4,5,6-Dibenzo-1,2-oxaphosphane-2-oxide	HCA(Sanko Chemical)	216.17	C12H9O2P		-	-
A(2)-201	3,5-Di- <i>t</i> -butyl-4-hydroxybenzylphosphite-diethylester	Irganox 1222(Ciba-Geigy)	356.44	C19H33O4P		-	-
A(2)-305	Tetrakis(2,4-di- <i>t</i> -butyl-5-methylphenyl)-4,4'-biphenylene diphosphonite	GSY-P101(Sakai Chemical Industry)	1091.71	C72H100O4P2		✓	-
A(2)-502	Triauryl trithiophosphite	-	635.15	C36H75PS3		-	✓

A(3)-001	Dilauryl-3,3'-thiodipropionate	Sumilizer TPL-R(Sumitomo Chemical), DLTP(Mitsubishi Pharma), Seenox DL(Shipro Kasei Kaisha), Nocrac 400(Ouchishinko Chemical Industrial), Cyanox LTDT Cyanox LTDP(Am. Cyanamid)	514.84	C30H58O4S	$S\{CH_2CH_2COOC_{12}H_{25}\}_2$	✓	-
A(3)-002	Ditridecyl-3,3'-thiodipropionate	Sumilizer TL(Sumitomo Chemical), ADK STAB AO-503A(Adeka), Cyanox 711(Am. Cyanamid)	542.44	C32H62O4S	$S\{CH_2CH_2COOC_{13}H_{27}\}_2$	✓	-
A(3)-003	Dimyristyl-3,3'-thiodipropionate	Sumilizer TPM(Sumitomo Chemical), DMTP(Mitsubishi Pharma), Seenox DM(Shipro Kasei Kaisha), Rasmit MG(Dai-ichi Kogyo Seiyaku), Cyanox MTDP(Am. Cyanamid)	570.95	C34H66O4S	$S\{CH_2CH_2COOC_{14}H_{29}\}_2$	✓	-
A(3)-004	Distearyl-3,3'-thiodipropionate	Sumilizer TPS(Sumitomo Chemical), DSTP(Mitsubishi Pharma), Seenox DS(Shipro Kasei Kaisha), OrnZsSG(Daiichi Kogyo), Cyanox STDP(Am. Cyanamid)	683.16	C42H82O4S	$S\{CH_2CH_2COOC_{18}H_{37}\}_2$	✓	-
A(3)-020	Pentaerythrityl tetrakis(beta-laurylthiopropionate)	Seenox 412S(Shipro Kasei Kaisha), Sumilizer TP-D(Sumitomo Chemical), ADK STAB AO412S(Adeka)	1160.81	C65H124O8S4	$(C_{12}H_{25}SCH_2CH_2COOCH_2)_4C$	✓	-

A(3)-040	Stearylthiopropionamide	-	357.64	C ₂₁ H ₄₃ NOS		✓	-
A(3)-100	Bis[2-methyl-4-(3- <i>n</i> -alkyl (C12-C14) thiopropionyloxy)-5- <i>t</i> -butylphenyl]sulfide	Mark AO 23(Adeka)	902.54 - 958.60	C ₅₂ H ₈₆ O ₄ S ₄ - C ₅₆ H ₉₄ O ₄ S ₄		-	-
A(3)-200	Diocetadecyldisulfide	Hostanox SE10(Hoechst)	570.52	C ₃₆ H ₇₄ S ₂		✓	-
A(3)-300	2-Mercaptobenzimidazole	Sumilizer MB(Sumitomo Chemical)	150.03	C ₇ H ₆ N ₂ S		-	-
A(3)-301	Methyl-2-mercaptobenzimidazole	Nocrac MMB(Ouchishinko Chemical Industrial)	164.04	C ₈ H ₈ N ₂ S		-	-
A(3)-400	1,1'-Thiobis(2-naphthol)	Plastanox 61(Am. Cyanamid)	318.07	C ₂₀ H ₁₄ O ₂ S		-	-
A(4)-110	Polymerized 2,2,4-trimethyl-1,2-dihydroquinoline	Nocrac 224(Ouchishinko Chemical Industrial)	-	(C ₁₂ H ₁₅ N) _n		-	✓
A(4)-116	<i>N,N'</i> -bis(2,2,6,6-tetramethyl-4-piperidyl)-1,3-benzenedicarboxamide	Nylostab S-EED(Clariant)	442.33	C ₂₆ H ₄₂ N ₄ O ₂		-	✓

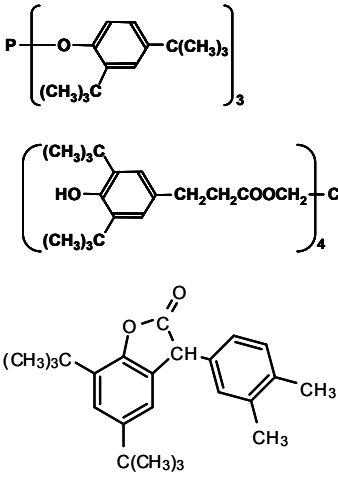
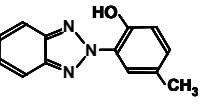
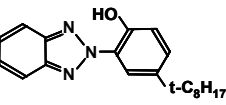
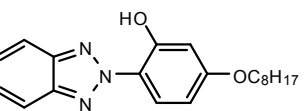
A(5)-007	Mixture of 5,7-Di- <i>t</i> -butyl-3-(3,4-dimethylphenyl)-3 <i>H</i> -benzofuran-2-one, Tris(2,4-di- <i>t</i> -butylphenyl) phosphite, Tetrakis[methylene 3-(3',5'-di- <i>t</i> -butyl-4-hydroxyphenyl)propionate]methane	Irganox HP 2215(Ciba Specialty)	646.45 1176.78 350.22	C42H63O3P C73H108O12 C24H3O2	 <p>Irganox 168 (57%)</p> <p>Irganox 1010 (28%)</p> <p>HP 136 (15%)</p>	-	✓
B(1)-001	2-(2'-Hydroxy-5'-methylphenyl) benzotriazole	Sumisorb 200(Sumitomo Chemical), Tinuvin P(Ciba-Geigy), ADK STAB LA32(Adeka), Seesorb 701(Shipro Kasei Kaisha), Tomisord 100(Mitsubishi Pharma)	225.09	C13H11N3O		-	-
B(1)-002	2-(2'-Hydroxy-5'- <i>t</i> -octylphenyl) benzotriazole	Tinuvin PS(Ciba-Geigy), Chemisorb 78(Shipro Kasei Kaisha, Ltd.)	323.43	C20H25N3O		-	-
B(1)-004	2-(2'-Hydroxy-4'-octoxyphenyl)benzotriazole	Seesorb 707(Shipro Kasei Kaisha)	339.19	C20H25N3O2		-	✓

B(1)-010	2-(2'-Hydroxy-3',5'-di- <i>t</i> -butylphenyl)benzotriazole	Sumisorb 320(Sumitomo Chemical), Seesorb 705(Shipro Kasei Kaisha), Biosorb 582(Kyodo Chemical), Tinuvin 320(Ciba-Geigy)	323.43	C ₂₀ H ₂₅ N ₃ O		-	-
B(1)-011	2-(2'-Hydroxy-3',5'-di- <i>t</i> -amylphenyl)benzotriazole	Sumisorb 320(Sumitomo Chemical),Tinuvin 328(Ciba-Geigy), Seesorb 704(Shipro Kasei Kaisha), Biosorb 591(Kyodo Chemical)	351.49	C ₂₂ H ₂₉ N ₃ O		-	-
B(1)-012	2-(2'-Hydroxy-3'-dodecyl-5'-methylphenyl)benzotriazole	Tinuvin 571(Ciba-Geigy)	393.56	C ₂₅ H ₃₅ N ₃ O		-	-
B(1)-013	2-[2'-Hydroxy-3',5'-bis(alpha,alpha-dimethylbenzyl)phenyl]-2 <i>H</i> -benzotriazole	Tinuvin 234(Ciba-Geigy)	447.57	C ₃₀ H ₂₉ N ₃ O		-	-
B(1)-015	<i>i</i> -Octyl-3-[3-(2 <i>H</i> -benzotriazol-2-yl)-5- <i>t</i> -butyl-4-hydroxyphenyl]propionate	Tinuvin 384-2(Ciba-Geigy)	451.28	C ₂₇ H ₃₇ N ₃ O ₃		-	-
B(1)-015a	Methyl-3-[3- <i>t</i> -butyl-5-(2 <i>H</i> -benzotriazol-2-yl)-4-hydroxyphenyl]propionic acid and polyethylene glycol 300	Tinuvin 1130(Ciba-Geigy)	603.31, 647.34, 924.46, 968.49, 282.17, 326.19	C ₃₁ H ₄₅ N ₃ O ₉ , C ₃₃ H ₄₉ N ₃ O ₁₀ , C ₅₀ H ₆₄ N ₆ O ₁₁ , C ₅₂ H ₆₈ N ₆ O ₁₂ , C ₁₂ H ₂₆ O ₇ , C ₁₄ H ₃₀ O ₈	 $R-(OCH_2CH_2)_{6,7}OH$ $R-(OCH_2CH_2)_{6,7}O-R$ $H-(OCH_2CH_2)_{6,7}OH$ $R=-(CH_2)_{2,3}C(=O)$	-	-

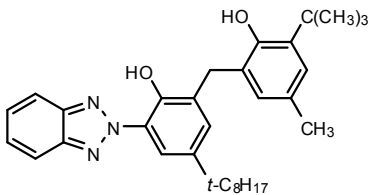
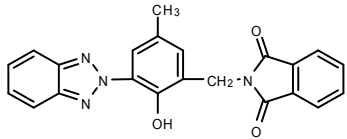
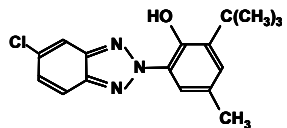
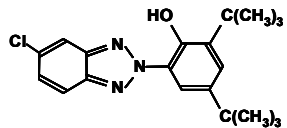
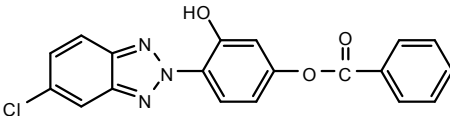
B(1)-016	6-(2-Benzotriazolyl)-4- <i>tert</i> -octyl-6'- <i>tert</i> -butyl-4'-methyl-2,2'-methylenebisphenol	JAST-500(Johoku Chemical)	499.32	C32H41N3O2		-	✓
B(1)-020	2-[2-Hydroxy-3'-(3'',4'',5'',6''-tetrahydrophthalimide methyl)-5'-methylphenyl]benzotriazole	Sumisorb 250(Sumitomo Chemical)	394.44	C22H22N4O3		✓	-
B(1)-050	2-(2'-Hydroxy-3'- <i>t</i> -butyl-5'-methylphenyl)-5-chlorobenzotriazole	Sumisorb 300(Sumitomo Chemical), ADK STAB 326(Adeka), Seesorb 703(Shipro Kasei Kaisha), Biosorb 550(Kyodo Chemical), Tinuvin 326(Ciba-Geigy)	315.11	C17H18ClN3O		-	-
B(1)-051	2-(2'-Hydroxy-3',5'-di- <i>t</i> -butylphenyl)-5-chlorobenzotriazole	Tinuvin 327(Ciba-Geigy), Biosorb 580(Kyodo Chemical), Chemisorb 72(Chemipro Kasei Kaisha)	357.88	C20H24ClN3O		-	-
B(1)-056	2-(4-Benzoyloxy-2-hydroxyphenyl)-5-chloro-2 <i>H</i> -benzotriazole	Seesorb 7012BA(Shipro Kasei Kaisha)	365.06	C19H12N3O3Cl		-	✓

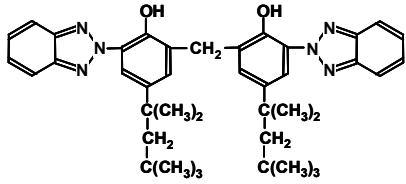
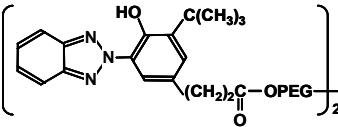
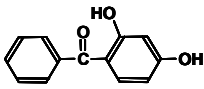
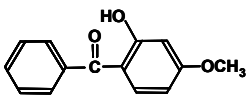
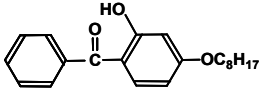
B(1)-100	2,2'-Methylenebis[4-(1,1,3,3-tetramethylbutyl)-6-(2H-benzotriazole-2-yl)phenol]	Mark LA-31, ADK STAB LA-31(Adeka)	658.87	C41H50N6O2		-	-
B(1)-101	Condensation product of methyl- 3-[3-(2H-benzotriazole-2-yl)-5- <i>t</i> -butyl-4-hydroxyphenyl]propionate and PEG 300	Tinuvin 213(Ciba-Geigy)	-	-		-	-
B(2)-010	2,4-Dihydroxybenzophenone	Seesorb 100(Shipro Kasei Kaisha), Uvinul 400(BASF), Inhibitor DHBP(Eastman), DHB Riedel(Hoechst)	214.06	C13H10O3		-	-
B(2)-011	2-Hydroxy-4-methoxybenzophenone	Sumisorb 110(Sumitomo Chemical), Seesorb 101(Shipro Kasei Kaisha), Biosorb 110(Kyodo Chemical), Cyasorb UV-9(Am. Cyanamid), Uninul M-40, Uvinul M-3040(BASF)	228.08	C14H12O3		-	-
B(2)-012	2-Hydroxy-4- <i>n</i> -octoxybenzophenone	Sumisorb 130(Sumitomo Chemical), Seesorb 102(Shipro Kasei Kaisha), Cyasorb UV-531(Am. Cyanamid), Uvinul M-40(BASF), ADK STAB 1413(Adeka)	326.19	C21H26O3		-	-

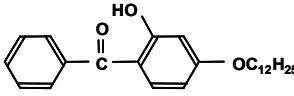
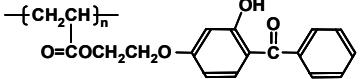
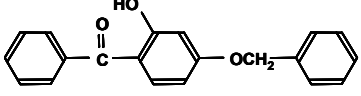
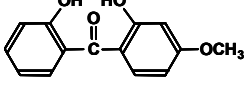
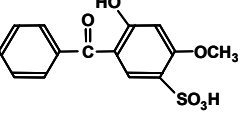
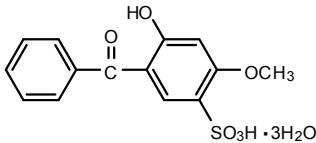
B(2)-013	2-Hydroxy-4- <i>n</i> -dodecyloxybenzophenone	Seesorb 103(Shipro Kasei Kaisha), Chemisorb 13(Chemipro Kasei Kaisha), DOBP(Eastman Chem.)	382.54	C25H34O3		-	-
B(2)-015	Poly-4-(2-acryloxyethoxy)-2-hydroxybenzophenone	Cyasorb UV-2126(Am. Cyanamid)	-	-		-	-
B(2)-016	2-Hydroxy-4-benzyloxybenzophenone	Seesorb 105(Shipro Kasei Kaisha), Sumisorb 120(Sumitomo Chemical), Chemisorb 15(Chemipro Kasei Kaisha)	304.11	C20H16O3		-	-
B(2)-020	2,2'-Dihydroxy-4-methoxybenzophenone	Cyasorb UV-24(Am. Cyanamid), Sumisorb 140(Sumitomo Chemical), Chemisorb 111(Chemipro Kasei Kaisha)	244.07	C14H12O4		-	-
B(2)-025	2-Hydroxy-4-methoxy-5-sulfoxybenzophenone	Uvinul MS-40(BASF), HMBS Riedel(Hoechst)	308.04	C14H12O6S		-	-
B(2)-025a	2-Hydroxy-4-methoxybenzophenone-5-sulfonic acid trihydrate	Seesorb 101S(Shipro Kasei Kaisha)	362.07	C14H18O9S		-	✓

B(2)-030	2,2'-Dihydroxy-4,4'-dimethoxybenzophenone	Uvinul D-49(BASF), Chemisorb 1011(Chemipro Kasei Kaisha)	274.08	C15H14O5		-	-
B(2)-031	2,2',4,4'-Tetrahydroxybenzophenone	Uvinul D-50(BASF), Sumisorb 150(Sumitomo Chemical), Chemisorb 1001(Chemipro Kasei Kaisha)	246.05	C13H10O5		-	-
B(2)-100	Bis(5-benzoyl-4-hydroxy-2-methoxyphenyl)methane	Mark LA-51(Adeka)	468.16	C29H24O6		✓	-
B(2)-120	1,4-Bis(4-benzoyl-3-hydroxyphenoxy)butane	Seesorb 151(Shipro Kasei Kaisha)	482.17	C30H26O6		-	✓
B(3)-001	Phenyl salicylate	Seesorb 201(Shipro Kasei Kaisha)	214.06	C13H10O3		-	-
B(3)-002	2,5-Di- <i>t</i> -butyl-4-hydroxybenzoic acid, <i>n</i> -hexadecyl ester	Cyasorb UV 2908(Am. Cyanamid)	474.76	C31H54O3		-	-
B(3)-010	4- <i>t</i> -Butylphenyl salicylate	Seesorb 202(Shipro Kasei Kaisha), Biosorb 90(Kyodo Chemical)	270.13	C17H18O3		✓	-

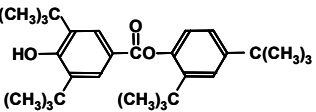
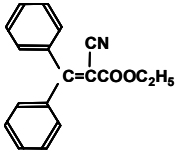
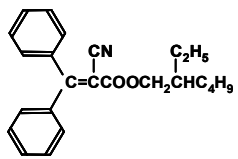
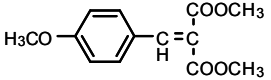
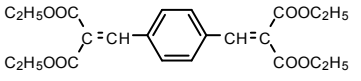
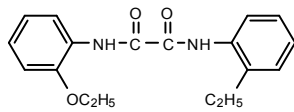
B(3)-030	2,4-Di- <i>t</i> -butylphenyl-3',5'-di- <i>t</i> -butyl-4'-hydroxybenzoate	Tinuvin 120(Ciba-Geigy), Sumisorb 400(Sumitomo Chemical), Seesorb 712(Shipro Kasei Kaisha), Chemisorb 112(Chemipro Kasei Kaisha), UV-Check AM-340(Ferro)	438.64	C29H42O3		✓	-
B(4)-001	Ethyl(beta,beta-diphenyl)cyanoacrylate	Seesorb 501(Shipro Kasei Kaisha), Biosorb 910(Kyodo Chemical)	277.11	C18H15NO2		-	-
B(4)-002	2-Ethylhexyl(beta,beta-diphenyl)cyanoacrylate	Uvinul N-539(BASF)	361.48	C24H27NO2		-	-
B(4)-022	Dimethyl (<i>p</i> -methoxybenzylidene)malonate	Hostavin PR-25(Clariant)	250.08	C13H14O5		-	✓
B(4)-026	Tetraethyl-2,2'-(1,4-phenylenedimethylidene)bismalonate	Hostavin B-CAP(Clariant)	418.16	C22H26O8		-	✓
B(5)-001	2-Ethyl-2'-ethoxy-oxalanilide	Hostavin VSU(Clariant)	312.15	C18H20N2O3		-	✓

B(6)-006	2-[4,6-Bis(2,4-dimethylphenyl)-1,3,5-triazin-2-yl]-5-(octyloxy) phenol	Cyasorb UV-1164(Cytec)	509.30	C33H39N3O2		-	✓
B(6)-024	2,2'-(1,4-Phenylene) bis-4 <i>H</i> -3,1-benzoxazin-4-one	Cyasorb UV-3638F(Cytec)	368.08	C22H12N2O4		-	✓
B(8)-010	2,2'-Thiobis(4- <i>t</i> -octylphenolate)- <i>n</i> -butylamine nickel II	Cyasorb UV-1084(Am. Cyanamid)	572.51	C32H51NNiO2S		-	-
B(8)-011	2,2'-Thiobis(4- <i>t</i> -octylphenolate)-2-ethylhexylamine nickel II	Seesorb 612NH(Shipro Kasei Kaisha)	628.62	C36H59NNiO2S		-	-
B(8)-100	Nickel dibutylidithiocarbamate	Antigene NBC(Sumitomo Chemical), UV-Check AM-104(Ferro)	467.45	C18H36N2NiS4		✓	-
B(9)-005	2,2,6,6-Tetramethyl-4-piperidinyl alkanoate	Cyasorb UV-3853(Am. Cyanamid)	-	-		-	-

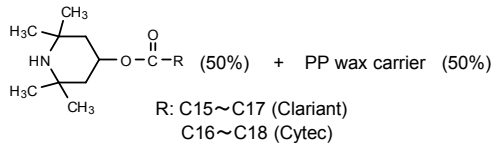
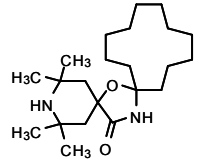
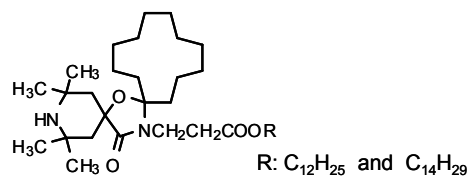
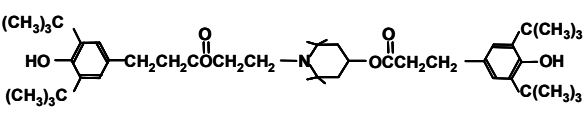
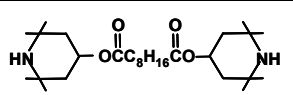
B(9)-005a	Mixture of esters of 2,2,6,6-tetramethyl-4-piperidinol with higher fatty acids and PP wax	Hostavin N845PP(Clariant), Cyasorb(Cytec)	395.38~423.41 (Clariant) 409.39~437.42 (Cytec)	C25H49NO2~ C27H53NO2 (Clariant) C26H51NO2~ C28H55NO2 (Cytec)	 <p>R: C15~C17 (Clariant) C16~C18 (Cytec)</p>	-	✓
B(9)-010	2,2,4,4-Tetramethyl-7-oxa-3,20-diazadispiro-[5.1.11.2]-heneicosan-21-one	Hostavin N 20(Clariant)	364.31	C22H40N2O2		-	✓
B(9)-012	Mixture of 2,2,4,4-Tetramethyl-20-(<i>beta</i> -myristyl and lauryl-oxycarbonyl)ethyl-7-oxa-3,20-diazadispiro-[5.1.11.2]-heneicosane-21-one	Hostavin N 24(Clariant)	604.52 (lauryl-) 632.55 (<i>beta</i> -myristyl-)	C37H68N2O4 (lauryl-) C39H72N2O4 (<i>beta</i> -myristyl-)	 <p>R: C₁₂H₂₅ and C₁₄H₂₉</p>	-	✓
B(9)-050	[4-(4-Hydroxy-3,5-di- <i>t</i> -butylphenyl)propionyl]- <i>N</i> -(4-hydroxy-3,5-di- <i>t</i> -butylphenyl)methyl-2,2,6,6-tetramethylpiperidine	Sanol LS 2626(Sankyo)	722.05	C45H71NO6		✓	-
B(9)-101	Bis(2,2,6,6-tetramethyl-4-piperidyl)sebacate	Sanol LS 770(Sankyo), ADK STAB LA-77(Adeka), Tomisorb 77(Mitsubishi Pharma), Tinuvin 770(Ciba-Geigy)	480.72	C28H52N2O4		✓	-

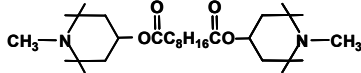
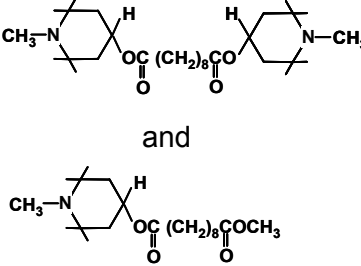
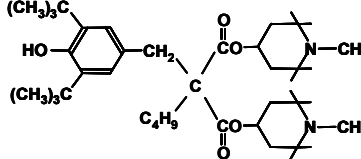
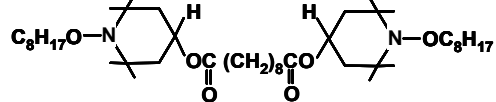
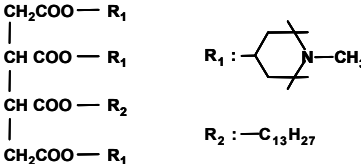
B(9)-150	Bis(<i>N</i> -methyl-2,2,6,6-tetramethyl-piperidyl)sebacate	Sanol LS 765(Sankyo), Tinuvin 765(Ciba-Geigy)	508.78	C30H56N2O4		-	-
B(9)-150a	Mixture of Bis(1,2,2,6,6-pentamethyl-4-piperidyl)-sebacate and 1-Methyl-8-(pentamethyl-4-piperidyl) sebacate	Tinuvin 292(Ciba-Geigy)	508.42+369.29	C30H56N2O4 + C21H39NO4		-	-
B(9)-151	Bis(1,2,2,6,6-pentamethyl-4-piperidyl)-2-(3,5-di- <i>t</i> -butyl-4-hydroxybenzyl)-2- <i>n</i> -butylmalonate	Tinuvin 144(Ciba-Geigy)	685.03	C42H72N2O5		✓	-
B(9)-160	Decanedioic acid, bis (2,2,6,6-tetramethyl-1-(octyloxy)-4-piperidyl) ester	Tinuvin 123(Ciba-Geigy)	737.63	C44H84N2O6		✓	-
B(9)-250	Condensation product of 1,2,3,4-butanetetracarboxylic acid and 1,2,2,6,6-pentamethyl-4-piperidinol and tridecylalcohol	Mark LA-62(Adeka)	875.69	C51H93N3O8		✓	-

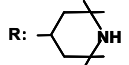
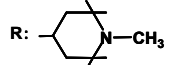
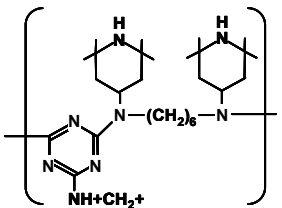
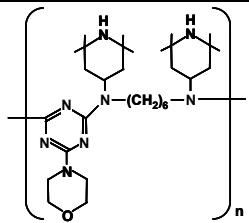
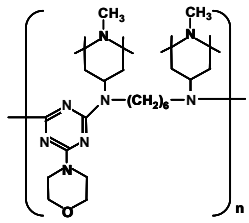
B(9)-300	Tetrakis (2,2,6,6-tetramethyl-4-piperidyl)-1,2,3,4-butanetetracarboxylate	Mark LA-57(Adeka)	791.11	C44H78N4O8	$\begin{array}{c} \text{CH}_2\text{COO} - \text{R} \\ \\ \text{CH COO} - \text{R} \\ \\ \text{CH COO} - \text{R} \\ \\ \text{CH}_2\text{COO} - \text{R} \end{array}$ 	✓	-
B(9)-350	Tetrakis (1,2,2,6,6-pentamethyl-4-piperidyl)-1,2,3,4-butanetetracarboxylate	Mark LA-52(Adeka)	847.22	C48H86N4O8	$\begin{array}{c} \text{CH}_2\text{COO} - \text{R} \\ \\ \text{CH COO} - \text{R} \\ \\ \text{CH COO} - \text{R} \\ \\ \text{CH}_2\text{COO} - \text{R} \end{array}$ 	✓	-
B(9)-400	Poly[[6-[(1,1,3,3-tetramethylbutyl)amino]-1,3,5-triazine-2,4-di-yl] [(2,2,6,6-tetramethyl-4-piperidyl) imino]hexamethylene[(2,2,6,6-tetramethyl-4-piperidyl)imino]]	Chimassorb 944 LD, Chimassorb 944 FD(Ciba-Geigy)	-	-		-	-
B(9)-401	Poly[(6-morpholinosis-triazin-2,4-diyl) [(2,2,6,6-tetramethyl-4-piperidyl) imino]-hexamethylene[(2,2,6,6-tetramethyl-4-piperidyl) imino]]	Cyasorb UV-3346(Am. Cyanamid)	-	-		-	-
B(9)-402	Poly[(6-morpholinosis-triazine-2,4-diyl) [(1,2,2,6,6-pentamethyl-4-piperidyl)imino]-hexamethylene[(1,2,2,6,6-pentamethyl-4-piperidyl)imino]]	Cyasorb UV-5329(Am. Cyanamid)	-	-		-	-

B(9)-403	Polymeric hindered amine light stabilizer	Chimassorb 2020FD(Ciba-Geigy)	-	-		-	-
B(9)-406	Polymer of 2,2,4,4-tetramethyl-7-oxa-3,20-diazadispiro-[5.1.11.2]-heneicosan-21-one and Epichlorohydrin	Hostavin N 30(Clarant)	>1500	-		-	✓
B(9)-410	Condensation product of 1,2,3,4-butanetetracarboxylic acid and 2,2,6,6-tetramethyl-4-piperidinol and beta,beta,beta',beta'-tetramethyl-3,9-(2,4,8,10-tetraoxaspiro [5,5] undecane)diethanol	Mark LA-68(Adeka)	-	-		-	-
B(9)-450	<i>N,N'</i> -Bis(3-aminopropyl)ethylenediamine-2,4-bis[<i>N</i> -butyl- <i>N</i> -(1,2,2,6,6-pentamethyl-4-piperidyl)amino]-6-chloro-1,3,5-triazine	Chimassorb 119 FL(Ciba-Geigy)	174.18 or 2284.05	C8H22N4 or C132H250N32		-	-

B(9)-451	Dimethyl succinatepolymer with tetramethyl hydroxy-1-hydroxyethyl piperidine	Tinuvin 622LD(Ciba-Geigy)	-	-		-	-
B(9)-452	Condensation products of 1,2,3,4-butanetetracarboxylic acid and 1,2,2,6,6-pentamethyl-4-piperidinol and beta,beta,beta',beta'-tetramethyl-3,9-(2,4,8,10-tetraoxaspiro [5,5] undecane)diethanol	Mark LA-63(Adeka)	-	-		-	-
B(9)-490	Poly[methyl-3-oxy-(2,2,6,6-tetramethyl-4-piperidyl)propylsiloxane]	Uvasil 299(EniChem)	-	-		-	-
B(10)-010	2-(4,6-Diphenyl-1,3,5-triazin-2-yl)-5-[(hexyl)oxy]-phenol	Tinuvin 1577FF(Ciba-Geigy)	425.52	C27H27N3O2		-	-

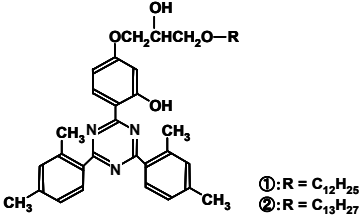
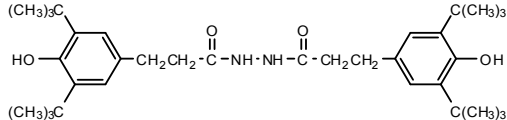
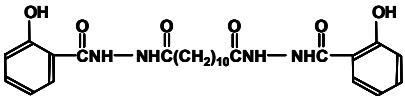
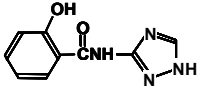
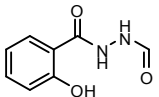
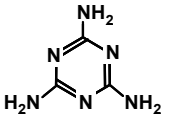
B(10)-015	2-[4-[(2-hydroxy-3-(dodecyl-/tridecyl-)oxypropyloxy]-2-hydroxyphenyl]-4,6-bis(2,4-dimethylphenyl)-1,3,5-triazine	Tinuvin 400(Ciba-Geigy)	639.4+653.42	C ₄₀ H ₅₃ N ₃ O ₄ + C ₄₁ H ₅₅ N ₃ O ₄	 <p>①: R = C₁₂H₂₅ ②: R = C₁₃H₂₇</p>	-	-
C(1)-001	<i>N,N'</i> -Bis[3-(3,5-di- <i>t</i> -butyl-4-hydroxyphenyl)propionyl]hydrazine	Irganox MD 1024(Ciba Specialty)	552.79	C ₃₄ H ₅₂ N ₂ O ₄		-	✓
C(1)-003	<i>N,N'</i> -Bis(2-hydroxybenzoyl)dodecanedihydrazide	Mark CDA-6(Adeka)	498.25	C ₂₆ H ₃₄ N ₄ O ₆		✓	-
C(2)-010	3-(<i>N</i> -salicyloyl)amino-1,2,4-triazole	Mark CDA-1(Adeka)	204.06	C ₉ H ₈ N ₄ O ₂		-	-
C(2)-020	<i>N'</i> -Formyl-2-hydroxybenzohydrazide	Stabinal CS-42(Sumitomo Chemical)	-	-		-	-
C(2)-030	Melamine	Mark ZS-27(Blend with other chemicals)(Adeka Corporation)	126.07	C ₃ H ₆ N ₆		-	-

D(3)-001	Lithium stearate	Kouseistab Li-St, S-7000(Sakai Chemical Industry), Li-St(Katsuta Kako)	290.28	C18H35LiO2	Li(C₁₇H₃₅COO)	✓	-
D(3)-010	Magnesium stearate	SM #1000(Sakai Chemical Industry), Kouseistab Mg-St, NS-M(Namariichi Chemical)	590.51	C36H70MgO4	Mg (C₁₇H₃₅COO)₂	✓	-
D(3)-020	Aluminium stearate	-	876.77	C54H105O6Al	Al (C₁₇H₃₅COO)₃	-	✓
D(3)-030	Calcium stearate	SC #100(Sakai Chemical Industry), Kouseistab Ca-St, CS-2, EC-102(Shinagawa Chemical Industry), NF-SC(Ferro), (NOF), (Kawamura Chemical)	606.49	C36H70CaO4	Ca (C₁₇H₃₅COO)₂	✓	-
D(3)-040	Zinc stearate	Stabinex NT-Z1(Mizusawa Industrial Chemicals), KS-100(Kikuchi Color & Chemicals), SZ #2000(Sakai Chemical Industry), (Kawamura Chemical)	630.45	C36H70O4Zn	Zn (C₁₇H₃₅COO)₂	✓	-
D(3)-042	Zinc laurate	-	462.27	C24H46O4Zn	Zn (C₁₁H₂₃COO)₂	-	✓

D(3)-043	Zinc 2-ethylhexanoate	Octope Zn(Hope Chemical)	350.14	C16H30O4Zn	$\text{Zn} \left[\text{CH}_3(\text{CH}_2)_3 \overset{\text{C}_2\text{H}_5}{\text{CH}} \text{COO} \right]_2$	-	-
D(3)-060	Barium stearate	(Shinagawa Chemical Industry), SB(Sakai Chemical Industry), Ba-St, BS-1, NS-FB(Nissan Chemical Industries)	704.43	C36H70BaO4	$\text{Ba} (\text{C}_{17}\text{H}_{35}\text{COO})_2$	✓	-
D(3)-063	Barium ricinoleate	Kouseistab BS-5	732.39	C36H66BaO6	$\text{Ba} \left[\text{CH}_3(\text{CH}_2)_5 \overset{\text{OH}}{\text{CH}} \text{CH}_2 \text{CH}=\text{CH}(\text{CH}_7)_7 \text{COO} \right]_2$	✓	-
D(3)-072	Lead 2-ethylhexanoate	Octope Pb(Hope Chemical)	494.19	C16H30O4Pb	$\text{Pb} \left[\text{CH}_3(\text{CH}_2)_3 \overset{\text{C}_2\text{H}_5}{\text{CH}} \text{COO} \right]_2$	-	-
D(3)-110	Dibasic lead phthalate	DLF	819.93	C8H4O6Pb3	$2\text{PbO} \cdot \text{Pb}(\text{C}_8\text{H}_4\text{O}_4)$	-	-
D(3)-120	Zinc benzoate	-	304.98	C14H9O4Zn	$\text{Zn} \left[\text{C}_6\text{H}_5\text{COO} \right]_2$	-	-
D(3)-121	<i>p</i> - <i>t</i> -Butyl zinc benzoate	Kouseistab Z-46	362.05	C18H18O4Zn	$\text{Zn} \left[(\text{CH}_3)_3\text{C}-\text{C}_6\text{H}_4-\text{COO} \right]_2$	-	-
D(3)-125	<i>p</i> - <i>t</i> -Butyl barium benzoate	-	436.03	C18H18BaO4	$\text{Ba} \left[(\text{CH}_3)_3\text{C}-\text{C}_6\text{H}_4-\text{COO} \right]_2$	-	-
D(4)-001	Dibutyltin dilaurate	ADK STAB BT-11(Adeka), Stann-SNT-1F(Sankyo Organic Chemicals), TS-101, -102, -110, Advastab T-12PJ(Katsuta Kako), TN-10(Sakai Chemical Industry)	632.38	C32H64O4Sn	$\text{C}_4\text{H}_9\text{Sn}(\text{C}_{11}\text{H}_{23}\text{O}_2)_2$	-	-

D(4)-002	Di- <i>n</i> -octyltin dilaurate	ADK STAB OT-1(Adeka), Stann BL(Sankyo Organic Chemicals), FD-10B, -10C, Advastab T-12PJ(Katsuta Kako), Kouseistab T-1200J	744.51	C40H80O4Sn		-	-
D(4)-100	Dibutyltin dimaleate	Stanclere TM(Akzo)	348.04	C12H20O4Sn		-	-
D(4)-110	Dibutyltin maleate polymer	KS-18, Advastab T-116J(Katsuta Kako)	-	-		-	-
D(4)-120	Dibutyltin bis(butyl maleate)	(Adeka), (Sankyo Organic Chemicals), (Katsuta Kako)	576.17	C24H40O8Sn		-	-
D(4)-405	Dimethyltin bis(octyl thioglycolate)	(Tokyo Fine Chemical), (Katsuta Kako)	560.20	C22H48O4S2Sn		-	-
D(4)-415	Dibutyltin bis(octyl thioglycolate)	(Tokyo Fine Chemical), (Katsuta Kako), (Adeka)	644.29	C28H60O4S2Sn		-	-
D(4)-425	Di- <i>n</i> -octyltin bis(isooctyl thioglycolate)	Stan OMZ-41F(Sankyo Organic Chemicals), TVS #8831(Nitto Kasei), ADK STAB 465E(Adeka)	752.39	C36H72O4S2Sn		-	-

D(5)-001	Tris(2-ethylhexyl) phosphite	JP 351(Johoku Chemical)	418.36	C24H51O3P	$[\text{C}_8\text{H}_{17}\text{O}]_3\text{—P}$	-	-
D(5)-002	Trisisodecyl phosphite	JP 310(Johoku Chemical), Chelex-TD(Sakai Chemical Industry)	502.45	C30H63O3P	$[\text{C}_{10}\text{H}_{21}\text{O}]_3\text{—P}$	-	-
D(5)-003	Tristearyl phosphite	JP 318E(Johoku Chemical), Chelex-S(Sakai Chemical Industry)	838.82	C54H111O3P	$[\text{C}_{18}\text{H}_{37}\text{O}]_3\text{—P}$	-	-
D(5)-010	Phenyldiisodecyl phosphite	Chelex-D(Sakai Chemical Industry), PDDP(Sanko Chemical), ADK STAB 517(Adeka)	438.33	C26H47O3P		-	-
D(5)-020	Diphenylisodecyl phosphite	Chelex-MD(Sakai Chemical Industry), JPM 311(Johoku Chemical), DPDP(Sanko Chemical), ADK STAB 135A(Adeka)	374.20	C22H31O3P		-	-
D(5)-032	Tris(nonylphenyl) phosphite	Sumilizer TNP(Sumitomo Chemical), ADK STAB TNP(Adeka), JP-351(Johoku Chemical), Weston 399(Borg Warner), Chelex TM(Sakai Chemical Industry)	688.50	C45H69O3P		-	-
D(5)-040	Trilauryl trithio phosphite	Weston TLTTP(Borg Warner), Chelex LT-3(Sakai Chemical Industry), JPS312(Johoku Chemical)	635.15	C36H75PS3	$[\text{C}_{12}\text{H}_{25}\text{S}]_3\text{—P}$	✓	-

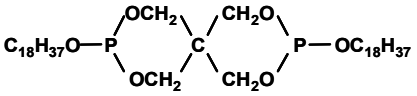
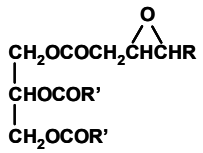
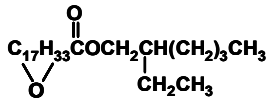
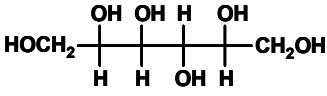
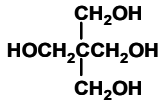
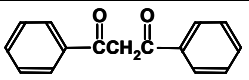
D(5)-101	Distearyl pentaerythritol diphosphite	Weston 618(Borg Warner), JPP 681S(Johoku Chemical), ADK STAB PEP-8(Adeka)	733.03	C41H82O6P2		✓	-
D(6)-001	Epoxy resin	Mark EP-13(Adeka)	-	-		-	-
D(6)-010	Epoxidized soybean oil	ADK CIZER O-130S, -130P(Adeka), NF-3000(Tokyo Fine Chemical)	-	-		-	-
D(6)-020	Epoxidized 2-ethylhexyl oleate	Epocizer(Dainippon Ink and Chemicals), ADK CIZER D-32(Adeka)	410.37	C26H50O3		-	-
D(6)-041	Sorbitol	-	182.08	C6H14O6		-	-
D(6)-042	Trimethylolpropane	-	134.09	C6H14O3	$\text{CH}_3\text{CH}_2\text{C}(\text{CH}_2\text{OH})_3$	-	-
D(6)-043	Pentaerythritol	-	136.07	C5H12O4		-	-
D(6)-044	Dipentaerythritol	-	254.14	C10H22O7	$(\text{HOCH}_2)_3\text{CCH}_2\text{OCH}_2\text{C}(\text{CH}_2\text{OH})_3$	-	-
D(6)-200	Dibenzoylmethane	Rhodiastab 83(Rhone Poulenc)	224.08	C15H12O2		-	-

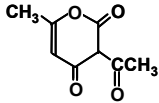
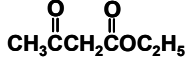
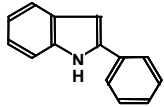
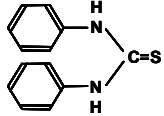
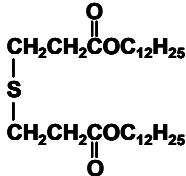
D(6)-210	Dehydroacetic acid	(Nippon Synthetic Chemical)	168.04	C ₈ H ₈ O ₄		-	-
D(6)-211	Ethyl acetoacetate	(Daicel Chemical Industries), (Nippon Synthetic Chemical)	130.06	C ₆ H ₁₀ O ₃		-	-
D(6)-300	2-Phenylindole	Advastab P-10J(Katsuta Kako)	193.09	C ₁₄ H ₁₁ N		-	-
D(6)-305	1,3-Diphenyl-2-thiourea	(Ouchishinko Chemical Industrial)	228.07	C ₁₃ H ₁₂ N ₂ S		-	-
D(6)-400	Dilauryl-3,3'-thiodipropionate	Sumilizer TPL-R(Sumitomo Chemical), DLTP(Mitsubishi Pharma), Seenox DL(Shipro Kasei Kaisha), Nocrac 400(Ouchishinko Chemical Industrial), Cyanox LTDT Cyanox LTDP(Am. Cyanamid)	514.40	C ₃₀ H ₅₈ O ₄ S		-	-
G(1)-001	Liquid paraffin	(Idemitsu Kosan), (Kyowayuka Kogyo), (Matsumura Oil), (ExxonMobil), (Union Sekiyu Kogyo), (Witco Chem)	-	-	-	-	-
G(1)-002	Paraffin wax [purified]	(Taniguchi Petroleum Refining), (Nippon Seiro), (Nippon Oil), (ExxonMobil)	-	-	C ₂₀ ~ C ₃₀	-	-

G(1)-005	Polyethylene, low molecular weight	SANWAX(Sanyo Chemical Industries), Mitsui Hi-wax(Mitsui Chemicals), Kalen A-73(Tokyo Fine Chemical), BASF WAX(BASF), Hoechst Wax PE520(Hoechst)	-	-	$\text{---}\{\text{CH}_2\text{CH}_2\}_n\text{---}$	-	-
G(1)-010	Polypropylene, low molecular weight	VISCOL 550-P(Sanyo Chemical Industries)	-	-	$\text{---}\{\text{CH}_2\underset{\text{CH}_3}{\text{CH}}\}_n\text{---}$	-	-
G(2)-003	Cetylalcohol	NAA-44(NOF)	242.26	C16H34O	$\text{CH}_3(\text{CH}_2)_{14}\text{CH}_2\text{OH}$	-	-
G(2)-005	Stearylalcohol	KALCOL 80(Kao), (New Japan Chemical), NAA-45(NFO)	270.29	C18H38O	$\text{CH}_3(\text{CH}_2)_{16}\text{CH}_2\text{OH}$	-	-
G(2)-100	Ethyleneglycol	-	62.04	C2H6O2	$\text{HOCH}_2\text{CH}_2\text{OH}$	-	-
G(2)-200	Polyethyleneglycol	(Sanyo Chemical Industries), (Yokkaichi Chemical Company), (NOF)	-	-	$\text{HO}\text{---}\{\text{CH}_2\text{CH}_2\text{O}\}_n\text{---}\text{H}$	-	-
G(3)-005	Stearic acid	ADEKA FATTY ACID SA-200(Adeka), LUNAC S-30(Kao), F-3, VLZ-66(Kawaken Fine Chemicals), (NOF), (Miyoshi Oil & Fat)	284.27	C18H36O2	$\text{CH}_3(\text{CH}_2)_{16}\text{COOH}$	-	-
G(3)-100	12-Hydroxystearic acid	KOW(Kawaken Fine Chemicals), (Kokura Synthetic Industries), Lexiol G21(Henkel)	300.27	C18H36O3	$\text{CH}_3(\text{CH}_2)_5\underset{\text{OH}}{\text{CH}}(\text{CH}_2)_{10}\text{COOH}$	-	-

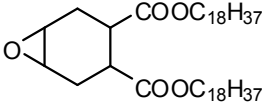
G(4)-005	Ethyl palmitate	-	284.27	C18H36O2	$\text{CH}_3(\text{CH}_2)_{14}\text{COOC}_2\text{H}_5$	-	-
G(4)-010	<i>n</i> -Butyl stearate	EXCEPARL BS(Kao), Butyl Stearate(Kawaken Fine Chemicals), ADK CIZER LS-8(Adeka)	340.33	C22H44O2	$\text{CH}_3(\text{CH}_2)_{16}\text{COOC}_4\text{H}_9$	-	-
G(4)-050	Cetyl 2-ethylhexanoate	EXEPARL HO(Kao)	368.36	C24H48O2	$\begin{array}{c} \text{CH}_3(\text{CH}_2)_3\text{CHCOOC}_{16}\text{H}_{33} \\ \\ \text{C}_2\text{H}_5 \end{array}$	-	✓
G(4)-051	Stearyl stearate	EXEPARL SS(Kao)	536.55	C36H72O2	$\text{C}_{17}\text{H}_{35}\text{COOC}_{18}\text{H}_{37}$	-	✓
G(4)-210	Castor oil, hydrogenated	KAOWAX 85-P(Kao)	-	-	-	-	✓
G(4)-600	Distearyl 4,5-epoxyhexahydrophthalate	RIKAFLOW EP-18(New Japan Chemical)	690.61	C44H82O5		-	✓
G(5)-205	Ethylene glycol monostearate	(Kawaken Fine Chemicals), (Chuokasei)	328.30	C20H40O3	$\text{CH}_3(\text{CH}_2)_{16}\text{COOCH}_2\text{CH}_2\text{OH}$	-	-
G(5)-215	Stearic acid monoglyceride	EXCEL T-95, EXCEL 150(Kao), Rikemal S-100, Rikemal S-200(Riken Vitamin)	358.31	C21H42O4	$\begin{array}{c} \text{CH}_2\text{OCOC}_{17}\text{H}_{35} \\ \\ \text{CHOH} \\ \\ \text{CH}_2\text{OH} \end{array}$	-	-

G(5)-216	Oleic acid monoglyceride	EXCEL O-95R(Kao)	356.29	C21H40O4	$\begin{array}{c} \text{CH}_2\text{OCOC}_{17}\text{H}_{33} \\ \\ \text{CHOH} \\ \\ \text{CH}_2\text{OH} \end{array}$	-	✓
G(6)-001	Zinc 2-ethylhexanoate	-	350.14	C16H30O4Zn	$\text{Zn} [\text{CH}_3(\text{CH}_2)_3\overset{\text{C}_2\text{H}_5}{\text{CH}}\text{COO}]_2$	-	-
G(6)-010	Calcium ricinolate	-	634.45	C36H66CaO6	$\text{Ca}[\text{CH}_3(\text{CH}_2)_5\overset{\text{OH}}{\text{CH}}\text{CH}=\text{C}_7\text{H}_{14}\text{COO}]_2$	-	-
G(6)-014	Calcium stearate	SC(Sakai Chemical Industry), (Shinagawa Chemical Industry), Stabinex NT-C1(Mizusawa Industrial Chemicals)	606.49	C36H70CaO4	$\text{Ca}(\text{C}_{17}\text{H}_{35}\text{COO})_2$	-	-
G(6)-015	Magnesium stearate	SM #1000(Sakai Chemical Industry)	591.51	C36H70MgO4	$\text{Mg}(\text{C}_{17}\text{H}_{35}\text{COO})_2$	-	-
G(6)-017	Cadmium stearate	DS-10(Katsuta Kako), KS-100(Kikuchi Color & Chemicals)	680.43	C36H70CdO4	$\text{Cd}(\text{C}_{17}\text{H}_{35}\text{COO})_2$	-	-
G(6)-018	Lead stearate	NS-100(Kikuchi Color & Chemicals),	672.43	C36H70O4Pd	$\text{Pb}(\text{C}_{17}\text{H}_{35}\text{COO})_2$	-	-
G(6)-019	Dibasic lead stearate	Stabinex NC-Z1(Mizusawa Industrial Chemicals), Kouseistab Pb-St, SL #1000(Sakai Chemical Industry), NS-2(Shinagawa Chemical Industry), NF-SP(Nissan Chemical Industries), NS-P	916.22	C36H70O6Pd3	$2\text{PbO} \cdot \text{Pb}(\text{C}_{17}\text{H}_{35}\text{COO})_2$	-	-

G(6)-105	Lithium 12-hydroxystearate	-	306.27	C18H35LiO3	$\text{CH}_3(\text{CH}_2)_5\underset{\text{OH}}{\text{CH}}(\text{CH}_2)_{10}\text{COOLi}$	-	-
G(7)-011	Fatty acids, montan-wax	Licowax S(Clariant)	424.43 - 480.49	C28H56O2 - C32H64O2	$\text{C}_{27}\text{H}_{55}\text{COOH} \sim \text{C}_{31}\text{H}_{63}\text{COOH}$	-	✓
G(7)-015	Fatty acids, montan-wax, ethylene esters	Licowax E(Clariant)	870.84 - 982.96	C58H110O4 - C66H126O4	$\text{C}_n\text{H}_{2n-1}\text{COOCH}_2\text{CH}_2\text{OCOC}_n\text{H}_{2n-1}$ (n=27~31)	-	✓
G(7)-018	Glycerides, montan-wax	Licolub WE 4(Clariant)	>800	-	$\begin{array}{c} \text{CH}_2\text{OCOC}_n\text{H}_{2n-1} \\ \\ \text{CHOCOC}_n\text{H}_{2n-1} \\ \\ \text{CH}_2\text{OCOC}_n\text{H}_{2n-1} \end{array}$ (n=27~31)	-	✓
G(7)-022	Fatty acids, montan-wax, mixed esters with adipic acid and trimethylolpropane	Licolub WE 40(Clariant)	1753.68 - 1977.92	C117H220O8 - C133H252O8	$\text{C}(\text{CH}_2\text{OCOC}_n\text{H}_{2n-1})_4$ (n=27~31)	-	✓
G(7)-023	Sodium montanoate	Hostamont NaV 101(Hoechst)	444.39 - 500.46	C28H53O2Na - C32H61O2Na	$\text{C}_n\text{H}_{2n-1}\text{COONa}$ (n=27~31)	-	-
G(7)-030	Partially esterified montan wax	Hoechst Wax OP(Hoechst)	-	-	-	-	-
G(7)-050	Carnauba wax	(Arakawa Chemical Industries), (Shinko Chemical)	-	-	-	-	-
G(7)-060	Bee's wax	-	-	-	-	-	-
G(8)-001	Lauric acid amide	Diamide Y(Nippon Kasei Chemical)	199.19	C12H25NO	$\text{CH}_3(\text{CH}_2)_{10}\overset{\text{O}}{\parallel}\text{CNH}_2$	-	-

G(8)-002	Palmitic acid amide	DIAMID KP(Nippon Kasei Chemical)	255.26	C16H33NO	$\text{CH}_3(\text{CH}_2)_{14}\overset{\text{O}}{\parallel}\text{CNH}_2$	-	✓
G(8)-003	Stearic acid amide	Diamide S, Amide AP-1(Nippon Kasei Chemical), Neutron-2(Nippon Fine Chemical), Alflow S-10(NOF)	283.29	C18H37NO	$\text{CH}_3(\text{CH}_2)_{16}\overset{\text{O}}{\parallel}\text{CNH}_2$	-	-
G(8)-004	Oleic acid amide	Diamide O(Nippon Kasei Chemical), Neutron(Nippon Fine Chemical), Armoslip(Lion Akzo)	281.27	C18H35NO	$\text{CH}_3(\text{CH}_2)_7\text{CH}=\text{CH}(\text{CH}_2)_7\overset{\text{O}}{\parallel}\text{CNH}_2$	-	-
G(8)-005	Erucic acid amide	Diamide L-200(Nippon Kasei Chemical), Neutron-22(Nippon Fine Chemical), Armoslip E(Lion Akzo), Alflow P-10(NOF)	337.33	C22H43NO	$\text{CH}_3(\text{CH}_2)_7\text{CH}=\text{CH}(\text{CH}_2)_{11}\overset{\text{O}}{\parallel}\text{CNH}_2$	-	-
G(8)-006	Behenic acid amide	DIAMID BL(Nippon Kasei Chemical)	339.35	C22H45NO	$\text{CH}_3(\text{CH}_2)_{20}\overset{\text{O}}{\parallel}\text{CNH}_2$	-	✓
G(8)-020	Hydroxystearic acid amide	DIAMID KH(Nippon Kasei Chemical)	299.28	C18H37NO2	$\text{CH}_3(\text{CH}_2)_5\underset{\text{OH}}{\text{CH}}(\text{CH}_2)_{10}\overset{\text{O}}{\parallel}\text{CNH}_2$	-	✓
G(8)-030	<i>N</i> -Oleyl palmitamide	PNT(Nippon Fine Chemical)	505.52	C34H67NO	$\text{CH}_3(\text{CH}_2)_{14}\overset{\text{O}}{\parallel}\text{CNH}(\text{CH}_2)_8\text{CH}=\text{CH}(\text{CH}_2)_7\text{CH}_3$	-	-
G(8)-031	<i>N</i> -Stearyl oleylamide	NIKKA AMIDE SO-1(Nippon Kasei Chemical)	533.55	C36H71NO	$\text{C}_{17}\text{H}_{33}\overset{\text{O}}{\parallel}\text{CNHC}_{18}\text{H}_{37}$	-	✓

G(8)-032	<i>N</i> -Stearyl erucamide	NIKKA AMIDE SE(Nippon Kasei Chemical)	589.61	C40H79NO	$\text{C}_{21}\text{H}_{41}\text{CNHC}_{18}\text{H}_{37}$	-	✓
G(8)-102	<i>N,N'</i> -Methylenebisstearic acid amide	DIAMID 200bisLA(Nippon Kasei Chemical)	578.57	C37H74N2O2	$\text{C}_{17}\text{H}_{35}\text{CNHCH}_2\text{NHCC}_{17}\text{H}_{35}$	-	✓
G(8)-105	<i>N,N'</i> -Ethylenebislauric acid amide	SLIPACKS L(Nippon Kasei Chemical)	424.40	C26H52N2O2	$\text{C}_{11}\text{H}_{23}\text{CNH}(\text{CH}_2)_2\text{NHCC}_{11}\text{H}_{23}$	-	✓
G(8)-106	Ethylenebis stearamide	Kao wax EB-P(Kao), Slipax L(Nippon Kasei Chemical), Armowax EBS-P(Lion Akzo), SN wax 22-DS	593.59	C38H76N2O2	$\text{C}_{17}\text{H}_{35}\text{CNH}(\text{CH}_2)_2\text{NHCC}_{17}\text{H}_{35}$	✓	-
G(8)-107	<i>N,N'</i> -Ethylenebisoleic acid amide	SLIPACKS O(Nippon Kasei Chemical)	588.56	C38H72N2O2	$\text{C}_{17}\text{H}_{33}\text{CNH}(\text{CH}_2)_2\text{NHCC}_{17}\text{H}_{33}$	-	✓
G(8)-200	Polycondensation product of ethylenediamine, stearic acid and sebacic acid	Light-amide WH-255, Light-amide WH-215(Kyoeisha Chemical)	-	-	$\text{C}_{17}\text{H}_{35}\text{CNH}(\text{CH}_2)_2\text{NH}[\text{C}(\text{CH}_2)_8\text{CNH}(\text{CH}_2)_2\text{NH}]_n\text{CC}_{17}\text{H}_{35}$	-	-
G(9)-001	Polydimethylsiloxane	KF 96 L(Shin-Etsu Silicones), TSF 451(GE Toshiba Silicones), SM 510(Dow Corning Toray)	-	-	$\begin{array}{c} \text{CH}_3 \\ \\ \text{-(Si-O)}_n \\ \\ \text{CH}_3 \end{array}$	-	-

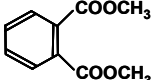
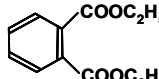
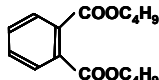
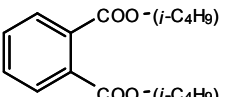
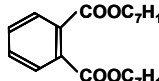
H(1)-001	Dimethyl phthalate	-	194.06	C10H10O4		-	-
H(1)-002	Diethyl phthalate	(Kyowa Hakko Kogyo), (Daihachi Chemical Industry), (Eastman Chem.), (W. R. Grace)	222.09	C12H14O4		-	-
H(1)-005	Dibutyl phthalate	DBP(Kyowa Hakko Kogyo), Sansocizer DBP(New Japan Chemical), Monocizer DBP(Dainippon Ink and Chemicals), (Chisso), (Kurogane Kasei), (Daihachi Chemical Industry)	278.15	C16H22O4		-	-
H(1)-006	Diisobutyl phthalate	-	278.15	C16H22O4		-	✓
H(1)-009	Diheptyl phthalate	Sansocizer DHP(New Japan Chemical), Chissocizer DHP(Chisso), (Daihachi Chemical Industry), (Kurogane Kasei), (Daihachi Chemical Industry), (Sekisui Chemical)	362.24	C22H34O4		-	-

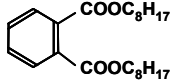
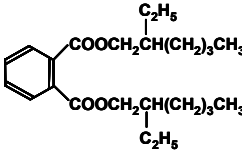
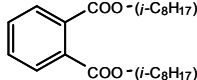
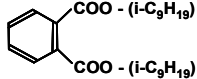
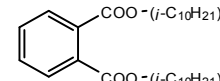
H(1)-011	Di- <i>n</i> -octyl phthalate	DnOP(Kyowa Hakko Kogyo), Chissocizer nDOP(New Japan Chemical), N-DOP(Daihachi Chemical Industry)	390.56	C24H38O4		-	-
H(1)-012	Bis(2-ethylhexyl) phthalate	Vinycizer 80(Kao), Sansocizer DOP(New Japan Chemical), Diacizer DOP(Mitsubishi Chemical MKV), Monocizer DOP(Dainippon Ink and Chemicals), Chissocizer DOP(New Japan Chemical)	390.28	C24H38O4		-	-
H(1)-013	Diisooctyl phthalate	-	390.28	C24H38O4		-	✓
H(1)-015	Diisononyl phthalate	Sansocizer DINP(New Japan Chemical), Diacizer DINP(Mitsubishi Chemical MKV), Monocizer DNP(Dainippon Ink and Chemicals), (Daihachi Chemical Industry), (Wacker Chemie)	418.31	C26H42O4		-	-
H(1)-017	Diisodecyl phthalate	-	446.34	C28H46O4		-	✓

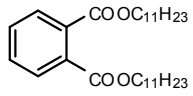
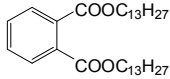
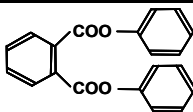
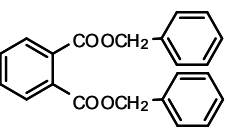
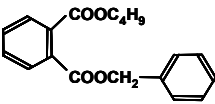
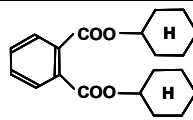
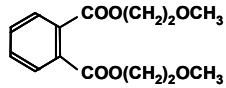
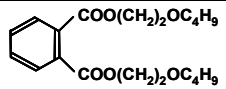
H(1)-019	Diundecyl phthalate	-	474.37	C30H50O4		-	✓
H(1)-021	Ditridecyl phthalate	Vincizer 20(Kao)	530.43	C34H58O4		-	-
H(1)-040	Diphenyl phthalate	-	318.09	C20H14O4		-	-
H(1)-041	Dibenzyl phthalate	-	346.12	C22H18O4		-	✓
H(1)-052	Benzylbutyl phthalate	Diacizer 160(Mitsubishi Chemical MKV), (Daihachi Chemical Industry), Santicizer 160(Monsanto), (Bayer)	312.14	C19H20O4		-	-
H(1)-061	Dicyclohexyl phthalate	DCHP(Osaka Organic Chemical Industry), (Pfizer), Edenol DCHP(Henkel)	330.18	C20H26O4		-	-
H(1)-070	Dimethoxyethyl phthalate	(Stauffer Chem.)	282.11	C14H18O6		-	-
H(1)-073	Dibutoxyethyl phthalate	Plasthall DBEP(C. P. Hall)	366.20	C20H30O6		-	-

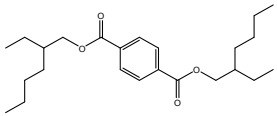
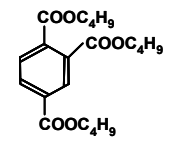
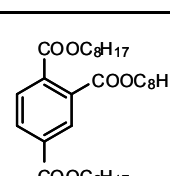
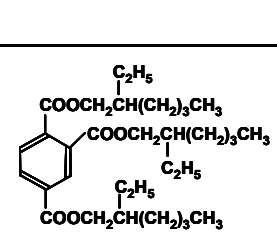
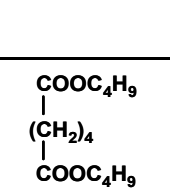
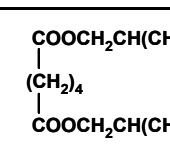
H(1)-075	Bis(2-ethylhexyl) terephthalate		390.28	C24H38O4			✓
H(1)-204	Tributyl trimellitate	(Kurogane Kasei)	378.20	C21H30O6		-	-
H(1)-209	Tri- <i>n</i> -octyl trimellitate	TRIMEX N-08(Kao)	546.39	C33H54O6		-	✓
H(1)-210	Tris(2-ethylhexyl) trimellitate	ADK cizer C-8(Adeka), Sansocizer TOTM(New Japan Chemical), Torimex T-08(Kao), Monocizer W-700(Dainippon Ink and Chemicals), (Daihachi Chemical Industry)	546.39	C33H54O6		-	-
H(2)-114	Di- <i>n</i> -butyl adipate	DBA(Daihachi Chemical Industry), (W. R. Grace)	258.18	C14H26O4		-	-
H(2)-115	Di-isobutyl adipate	DIBA(Daihachi Chemical Industry), Vynecizer 40(Kao)	258.18	C14H26O4		-	-

H(2)-119	Bis(2-ethylhexyl) adipate	DOA(Kyowa Hakkō Kogyō), Sansocizer DOA(New Japan Chemical), Diacizer DOA(Mitsubishi Chemical MKV), Monocizer DOA(Dainippon Ink and Chemicals)	370.31	C22H42O4	$\begin{array}{c} \text{C}_2\text{H}_5 \\ \\ \text{COOCH}_2\text{CH}(\text{CH}_2)_3\text{CH}_3 \\ \\ (\text{CH}_2)_4 \\ \\ \text{COOCH}_2\text{CH}(\text{CH}_2)_3\text{CH}_3 \\ \\ \text{C}_2\text{H}_5 \end{array}$	-	-
H(2)-121	Di-isononyl adipate	Sansocizer DINA(New Japan Chemical), Diacizer DINA(Mitsubishi Chemical MKV)	398.34	C24H46O4	$\begin{array}{c} \text{COO} - (\text{i-C}_9\text{H}_{19}) \\ \\ (\text{CH}_2)_4 \\ \\ \text{COO} - (\text{i-C}_9\text{H}_{19}) \end{array}$	-	-
H(2)-123	Di-isodecyl adipate	Sansocizer DIDA(New Japan Chemical), Diacizer DIDA(Mitsubishi Chemical MKV), Sekisuicizer #90(Sekisui Chemical), Vincyizer 50(Kao)	426.37	C26H50O4	$\begin{array}{c} \text{COO} - (\text{i-C}_{10}\text{H}_{21}) \\ \\ (\text{CH}_2)_4 \\ \\ \text{COO} - (\text{i-C}_{10}\text{H}_{21}) \end{array}$	-	-
H(2)-136	Dibutoxyethoxy ethyl adipate	-	434.29	C22H42O8	$\begin{array}{c} \text{COOC}_2\text{H}_4\text{OC}_2\text{H}_4\text{OC}_4\text{H}_9 \\ \\ (\text{CH}_2)_4 \\ \\ \text{COOC}_2\text{H}_4\text{OC}_2\text{H}_4\text{OC}_4\text{H}_9 \end{array}$	-	✓
H(2)-200	Dimethyl azelate	-	216.14	C11H20O4	$\begin{array}{c} \text{COOCH}_3 \\ \\ (\text{CH}_2)_7 \\ \\ \text{COOCH}_3 \end{array}$	-	✓

H(2)-210	Bis(2-ethylhexyl) azelate	Sansocizer DOZ(New Japan Chemical), DOZ(Daihachi Chemical Industry), (Kurogane Kasei), (C. P. Hall), (Pfizer)	412.35	C25H48O4	$\begin{array}{c} \text{C}_2\text{H}_5 \\ \\ \text{COOCH}_2\text{CH}(\text{CH}_2)_3\text{CH}_3 \\ \\ (\text{CH}_2)_7 \\ \\ \text{COOCH}_2\text{CH}(\text{CH}_2)_3\text{CH}_3 \\ \\ \text{C}_2\text{H}_5 \end{array}$	-	-
H(2)-300	Dimethyl sebacate	-	230.15	C12H22O4	$\begin{array}{c} \text{COOCH}_3 \\ \\ (\text{CH}_2)_8 \\ \\ \text{COOCH}_3 \end{array}$	-	-
H(2)-305	Di-n-butyl sebacate	(Kyowa Hakko Kogyo), (Kurogane Kasei), (Daihachi Chemical Industry), (C. P. Hall), (W. R. Grace), (Wacker Chemie)	314.24	C18H34O4	$\begin{array}{c} \text{COOC}_4\text{H}_9 \\ \\ (\text{CH}_2)_8 \\ \\ \text{COOC}_4\text{H}_9 \end{array}$	-	-
H(2)-310	Di-2-ethylhexyl sebacate	-	426.37	C26H50O4	$\begin{array}{c} \text{CH}_3 \\ \\ \text{COOCH}_2\text{CH}(\text{CH}_2)_3\text{CH}_3 \\ \\ (\text{CH}_2)_8 \\ \\ \text{COOCH}_2\text{CH}(\text{CH}_2)_3\text{CH}_3 \\ \\ \text{CH}_3 \end{array}$	-	-
H(2)-411	Dimethyl dodecanedioate	-	258.18	C14H26O4	$\begin{array}{c} \text{COOCH}_3 \\ \\ (\text{CH}_2)_{10} \\ \\ \text{COOCH}_3 \end{array}$	-	✓
H(2)-505	Di-n-butyl tartrate	-	262.14	C12H22O6	$\begin{array}{c} \text{COOC}_4\text{H}_9 \\ \\ (\text{CHOH})_2 \\ \\ \text{COOC}_4\text{H}_9 \end{array}$	-	-

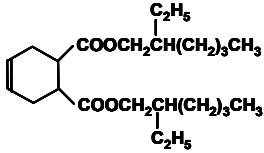
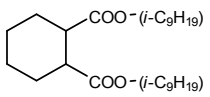
H(2)-602	Triethyl citrate	Citroflex 2(Pfizer)	276.12	C12H20O7	$\begin{array}{c} \text{CH}_2\text{COOC}_2\text{H}_5 \\ \\ \text{HOCCOOC}_2\text{H}_5 \\ \\ \text{CH}_2\text{COOC}_2\text{H}_5 \end{array}$	-	-
H(2)-605	Tributyl citrate	Citroflex 4(Pfizer)	360.21	C18H32O7	$\begin{array}{c} \text{CH}_2\text{COOC}_4\text{H}_9 \\ \\ \text{HOCCOOC}_4\text{H}_9 \\ \\ \text{CH}_2\text{COOC}_4\text{H}_9 \end{array}$	-	-
H(2)-631	Triethyl O-acetylcitrate	Citroflex A-2(Morflex)	318.13	C14H22O8	$\begin{array}{c} \text{CH}_2\text{COOC}_2\text{H}_5 \\ \\ \text{CH}_3\text{COOCCOOC}_2\text{H}_5 \\ \\ \text{CH}_2\text{COOC}_2\text{H}_5 \end{array}$	-	✓
H(2)-635	Tributyl acetylcitrate	Monocizer ATBC(Dainippon Ink and Chemicals), ATBC(Kyowa Hakko Kogyo), Citroflex A-4(Pfizer)	402.22	C20H34O8	$\begin{array}{c} \text{CH}_2\text{COOC}_4\text{H}_9 \\ \\ \text{CH}_3\text{COOCCOOC}_4\text{H}_9 \\ \\ \text{CH}_2\text{COOC}_4\text{H}_9 \end{array}$	-	-
H(3)-010	Bis(2-ethylhexyl) tetrahydrophthalate	Sansocizer DOTP(New Japan Chemical), (Eastman Chem.)	394.31	C24H42O4		-	-
H(3)-020	1,2-Cyclohexanedicarboxylic acid, diisononyl ester	Hexamoll DINCH(BASF)	424.35	C26H48O4		-	✓
H(4)-075	Butyl oleate	Vincizer 30(Kao), (C. P. Hall)	338.32	C22H42O2	$\text{CH}_3(\text{CH}_2)_7\text{CH}=\text{CH}(\text{CH}_2)_7\text{COOC}_4\text{H}_9$	-	-

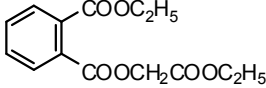
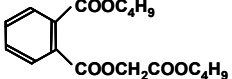
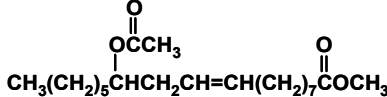
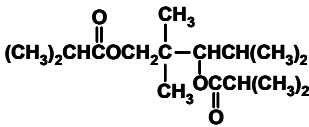
H(4)-114	Ethylphthalyl ethylglycolate	-	280.09	C14H16O6		-	✓
H(4)-118	n-Butyl phthalylbutyl glycolate	Santicizer 180(Monsanto)	336.16	C18H24O6		-	-
H(4)-130	Methyl O-acetylricinolate	MAR-N(Daihachi Chemical Industry)	354.28	C21H38O4	 $\text{CH}_3(\text{CH}_2)_5\text{CHCH}_2\text{CH}=\text{CH}(\text{CH}_2)_7\text{COCH}_3$	-	-
H(4)-210	Methyl pentachlorostearate	ADK cizer S-3(Adeka), (NOF)	470.09	C19H33Cl5O2	$\text{C}_{17}\text{H}_{30}\text{Cl}_5\text{COOCH}_3$	-	-
H(5)-010	2,2,4-Trimethyl-1,3-pentanediol isobutyrate	CS-16(Chisso), Kodaflex TXIB(Eastman Chem.)	286.21	C16H30O4		-	-
H(5)-100	Glycerol triacetate	Triacetin(Daihachi Chemical Industry)	218.08	C9H14O6	$\text{CH}_3\text{COOCH}_2\text{CH}(\text{OCOCH}_3)\text{CH}_2\text{OCOCH}_3$	-	-
H(5)-114	Glycerol diacetyl monolaurate	Rikemal PL-012(Riken Vitamin)	358.23	C19H34O6	$\text{CH}_3\text{COOCH}_2\text{CH}(\text{OCOC}_{11}\text{H}_{23})\text{CH}_2\text{OCOCH}_3$	-	-
H(5)-538	Propyleneglycol monostearate	-	342.31	C21H42O3	$\text{C}_{17}\text{H}_{35}\text{COOCH}_2\text{CH}(\text{OH})\text{CH}_3$	-	✓
H(5)-552	Polyethyleneglycol monolaurate	CPH-43-N(C. P. Hall)	-	-	$\text{C}_{11}\text{H}_{23}\text{COO}(\text{CH}_2\text{CH}_2\text{O})_n\text{H}$	-	-

H(5)-554	Poly(ethylene glycol) monooleate	-	-	-	$C_{17}H_{33}COO(CH_2CH_2O)_nH$	-	✓
H(6)-110	Epoxidized 2-ethylhexyl oleate	ADK cizer D-32(Adeka), Epocizer W-131(Dainippon Ink and Chemicals)	-	-	-	-	-
H(7)-030	Glycerin	(Daicel Chemical Industries, Ltd), (Lion)	92.05	C3H8O3	$\begin{array}{c} CH_2OH \\ \\ CHOH \\ \\ CH_2OH \end{array}$	-	-
H(8)-002	Triethyl phosphate	TEP(Daihachi Chemical Industry), (Kurogane Kasei)	182.07	C6H15O4P	$O=P-(OC_2H_5)_3$	-	-
H(8)-004	Tributyl phosphate	TBP(Daihachi Chemical Industry), (Showa Ether), (Monsanto), (Bayer), (Stauffer)	266.16	C12H27O4P	$O=P-(OC_4H_9)_3$	-	-
H(8)-008	Tris(2-ethylhexyl)phosphate	TOP(Daihachi Chemical Industry), (Bayer)	434.35	C24H51O4P	$O=P-\left\{ \begin{array}{c} OCH_2CH(CH_2)_3CH_3 \\ \\ CH_2CH_3 \end{array} \right\}_3$	-	-
H(8)-020	Triphenyl phosphate	-	326.07	C18H15O4P	$O=P\left\{ \begin{array}{c} \text{---} \text{C}_6\text{H}_5 \\ \\ \text{---} \end{array} \right\}_3$	-	-
H(8)-021	Tricresyl phosphate	Sansocizer TCP(New Japan Chemical), (Kyowa HAKKO Kogyo), (Kurogane Kasei), (Daihachi Chemical Industry), (Monsanto), (Bayer), (Stauffer)	368.12	C21H21O4P	$O=P\left\{ \begin{array}{c} \text{---} \text{C}_6\text{H}_4\text{---} \\ \\ \text{---} \end{array} \right\}_3$	-	-

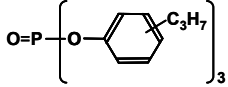
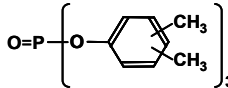
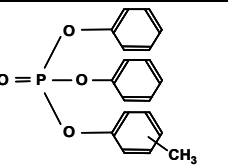
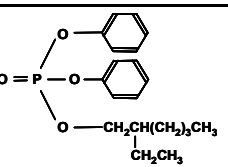
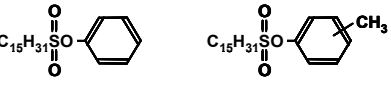
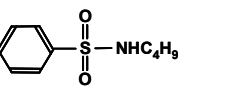
H(8)-023	Tris(isopropylphenyl) phosphate	Reofos 95(Ajinomoto)	452.21	C27H33O4P		-	-
H(8)-027	Trixylenyl phosphate	TXP(Daihachi Chemical Industry)	410.16	C24H27O4P		-	-
H(8)-030	Cresyl diphenyl phosphate	CDP(Daihachi Chemical Industry), Santicizer 140(Monsanto), (Bayer), (Stauffer)	340.09	C19H17O4P		-	-
H(8)-040	2-Ethylhexyldiphenyl phosphate	# 41(Daihachi Chemical Industry), Santicizer 141(Monsanto)	362.16	C20H27O4P		-	-
H(9)-001	Phenol/cresol pentadecane sulfonic ester	Mesamoll(Bayer)	368.24, 382.25	C21H36O3S, C22H38O3S		-	-
H(9)-100	<i>N-n</i> -Butylbenzenesulfonamide	BMB Yoshitomi(MitsubishiPharma), BM-4(Daihachi Chemical Industry), Plasthall BSA(C. P. Hall)	213.08	C10H15NO2S		-	-
H(10)-001	Paraffin oil	-	-	-	-	-	-
H(10)-200	Chlorinated paraffin	Empara 40(Ajinomoto), Toyoparax A40(Tosoh), ADK cizer E-410(Adeka), Clorafin 40(Hercules)	-	-	-	-	-

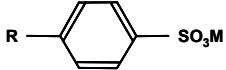
I(1)-003	Alkyl trimethyl ammonium salt	-	207.17 - 403.39	C ₁₁ H ₂₆ NCl - C ₂₅ H ₅₄ NCl	$\left[\begin{array}{c} \text{CH}_3 \\ \\ \text{R} - \text{N}^+ - \text{CH}_3 \\ \\ \text{CH}_3 \end{array} \right] \text{Cl}^-$ R: C ₈ ~ C ₂₂	-	-
I(1)-007	Dialkyl dimethyl ammonium salt	-	305.28 - 585.60	C ₁₈ H ₄₀ NCl - C ₃₈ H ₈₀ NCl	$\left[\begin{array}{c} \text{R} \\ \\ \text{R} - \text{N}^+ - \text{CH}_3 \\ \\ \text{CH}_3 \end{array} \right] \text{Cl}^-$ R: C ₈ ~ C ₁₆	-	-
I(1)-023	Benzalkonium salt	-	283.21 - 479.42	C ₁₇ H ₃₀ NCl - C ₃₁ H ₅₈ NCl	$\left[\begin{array}{c} \text{CH}_3 \\ \\ \text{R} - \text{N}^+ - \text{CH}_2 - \text{C}_6\text{H}_5 \\ \\ \text{CH}_3 \end{array} \right] \text{Cl}^-$ R: C ₈ ~ C ₂₂	-	-
I(1)-063	(3-Lauramidopropyl) trimethylammonium methylsulfate	Cyastat LS(Cytec)	410.28	C ₁₉ H ₄₂ N ₂ O ₅ S	$\left[\begin{array}{c} \text{CH}_3 \\ \\ \text{C}_{11}\text{H}_{23}\text{CONH}(\text{CH}_2)_3 - \text{N}^+ - \text{CH}_3 \\ \\ \text{CH}_3 \end{array} \right] \text{CH}_3\text{OSO}_3^-$	-	✓
I(1)-083	Stearamidopropyl dimethyl-2-hydroxyethylammonium nitrate	Cyastat SN(Cytec)	475.4	C ₂₅ H ₅₃ N ₃ O ₅	$\left[\begin{array}{c} \text{CH}_3 \\ \\ \text{C}_{17}\text{H}_{35}\text{CONH}(\text{CH}_2)_3 - \text{N}^+ - (\text{CH}_2)_2\text{OH} \\ \\ \text{CH}_3 \end{array} \right] \text{NO}_3^-$	-	✓
I(1)-200	Cationic polymer	Reolex AS-170(Dai-Ichi Kogyo Seiyaku)	-	-	-	-	-
I(2)-001	Alkyl sulfonate	-	-	-	RSO₃M	-	-
I(2)-010	Alkylbenzensulfonate	-	-	-		-	-
I(2)-100	Alkyl sulfate	-	-	-	ROSO₃M	-	-

I(2)-200	Alkyl phosphate	-	-	-	$\begin{array}{c} \text{R} - \text{O} \\ \quad \quad \quad \backslash \\ \quad \quad \quad \text{P} \\ \quad \quad \quad / \\ \text{O} = \end{array} \begin{array}{l} \text{OM} \\ \text{OM} \end{array}$	-	-
I(3)-010	Stearic acid monoglyceride	Electrostripper TS-5(Kao), Leostat GS90(Lion), Resistat PE 132(contains 5% of other chemicals)(Dai-Ichi Kogyo Seiyaku)	358.31	C21H42O4	$\begin{array}{c} \text{O} \\ \parallel \\ \text{CH}_2\text{OCC}_{17}\text{H}_{35} \\ \\ \text{CHOH} \\ \\ \text{CH}_2\text{OH} \end{array}$	✓	-
I(3)-033	Sorbitan monopalmitate	-	402.30	C22H42O6	$\begin{array}{c} \text{O} \\ \diagup \quad \diagdown \\ \text{CH}_2 \quad \text{CH} - \text{CH}_2\text{OCOR} \\ \quad \\ \text{OH} - \text{CH} \quad \text{CH} - \text{OH} \\ \\ \text{CH} \\ \\ \text{OH} \end{array} \quad \text{and} \quad \begin{array}{c} \text{OH} - \text{CH} - \text{CH} - \text{OH} \\ \quad \\ \text{CH}_2 \quad \text{CH} - \text{CH} - \text{CH}_2\text{OCOR} \\ \quad \\ \quad \text{OH} \end{array}$ <p style="text-align: center;">R: C₁₅H₃₁</p>	✓	-
I(3)-034	Sorbitan monostearate	-	430.33	C24H46O6	$\begin{array}{c} \text{O} \\ \diagup \quad \diagdown \\ \text{CH}_2 \quad \text{CH} - \text{CH}_2\text{OCOR} \\ \quad \\ \text{OH} - \text{CH} \quad \text{CH} - \text{OH} \\ \\ \text{CH} \\ \\ \text{OH} \end{array} \quad \text{and} \quad \begin{array}{c} \text{OH} - \text{CH} - \text{CH} - \text{OH} \\ \quad \\ \text{CH}_2 \quad \text{CH} - \text{CH} - \text{CH}_2\text{OCOR} \\ \quad \\ \quad \text{OH} \end{array}$ <p style="text-align: center;">R: C₁₇H₃₅</p>	✓	-
I(3)-100	Alkyl diethanolamine	Electrostripper EA(Kao), Armostat 310(Lion Akzo), Denon 311P(Marubishi Oil Chemical), (Toho Chemical Industry)	-	-	$\text{RN} \begin{array}{l} \text{CH}_2\text{CH}_2\text{OH} \\ \text{CH}_2\text{CH}_2\text{OH} \end{array}$	-	-
I(3)-200	Alkyl diethanolamide	Leostat S(Lion)	-	-	$\text{RCON} \begin{array}{l} \text{CH}_2\text{CH}_2\text{OH} \\ \text{CH}_2\text{CH}_2\text{OH} \end{array}$	-	-
I(3)-305	Poly(oxyethylene) alkyl ether	Peregal O(GAF)	-	-	$\text{RO}(\text{CH}_2\text{CH}_2\text{O})_n\text{H}$	-	-

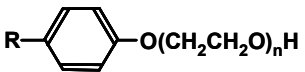
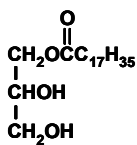
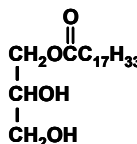
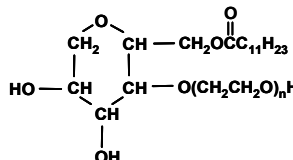
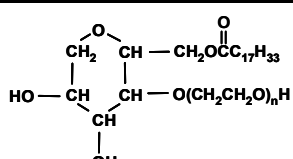
I(3)-320	Poly(oxyethylene) alkylphenyl ether	Igepal(Rhone-Poulenc)	-	-		-	-
I(3)-340	Poly(ethylene glycol) monolaurate	-	-	-	$C_{11}H_{23}COO(CH_2CH_2O)_nH$	-	-
I(3)-360	Poly(oxyethylene) alkyl amine	Ethomen(Akzo)	-	-	$RN \begin{cases} (CH_2CH_2O)_mH \\ (CH_2CH_2O)_nH \end{cases}$	-	-
I(3)-380	Poly(oxyethylene) alkyl amide	Ethomid O/15(Akzo)	-	-	$RCON \begin{cases} (CH_2CH_2O)_mH \\ (CH_2CH_2O)_nH \end{cases}$	-	-
J(1)-012	Stearic acid monoglyceride	Excel T-95(Kao)	358.31	C21H42O4		-	-
J(1)-013	Oleic acid monoglyceride	Excel 300(Kao)	356.29	C21H40O4		✓	-
J(2)-022	Poly(oxyethylene) sorbitan monolaurate	Rikemal S-105(Riken Vitamin)	-	-		-	-
J(2)-025	Poly(oxyethylene) sorbitan monooleate	Rikemal O-120(Riken Vitamin)	-	-		-	-

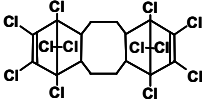
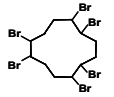
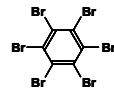
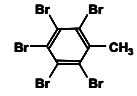
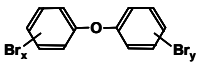
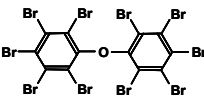
K(1)-005	Chlorinated paraffin	Empara 70(Ajinomoto), Empara(Tosoh)	-	-		-	-
K(1)-035	Dodecachloropentacyclo octadecadiene	Dechlorane Plus 515, 25, 35(Occidental Chemical)	656.79	C ₁₈ H ₂₁ Cl ₁₂		✓	-
K(2)-028	Hexabromocyclododecane	Unflame FSB-164(NOF), Flamecut 130R(Tosoh), Saytex HBCD-LM(Ethyl Corp), FR-1206(Dead Sea Bromine), CD-75P(Great Lakes)	635.65	C ₁₂ H ₁₈ Br ₆		✓	-
K(2)-042	Hexabromobenzene	AFR-1001(Asahi Glass), FR-B(Nippon Chemicals), HBB(Manac)	545.51	C ₆ Br ₆		-	-
K(2)-044	Pentabromotoluene	PBT(Manac), FR-705(Dead Sea Bromine)	481.61	C ₇ H ₃ Br ₅		-	-
K(2)-104	Octabromodiphenyl ether	Unflame FSB-190(NOF), Saytex 111(Ethyl Corp.), FR-1205(Dead Sea Bromine)	793.36	C ₁₂ H ₂ Br ₈ O	 x + y = 8	-	-
K(2)-106	Decabromodiphenyl ether	Unflame FSB-183(NOF), FR-PE(Nippon Chemicals), EB-10(Manac), Saytex 102E(Ethyl Corp.), FR-1210(Dead Sea Bromine), DE-83(Great Lakes Chem.)	949.18	C ₁₂ Br ₁₀ O		-	-

K(2)-132	Bis(tribromophenoxy) ethane	FF-680(Great Lakes Chem.)	685.59	C14H12Br6O2		-	-
K(2)-142	Ethylenebis(pentabromobiphenyl)	Saytex 8010(Ethyl Corp.)	961.21	C14H4Br10		-	-
K(2)-162	Tetrabromobisphenol A	Firegard 2000(Teijin Chemicals), AFR-1010(Asahi Glass), Flamecut 120R(Tosoh), Saytex RB-100(Ethyl Corp.), FR-1524(Dead Sea Bromine)	539.76	C15H12Br4O2		-	-
K(2)-168	Tetrabromobisphenol A, bis(2,3-dibromopropyl ether)	Firegard 3100(Teijin Chemicals), Unflame FSB-310(NOF), PE 68(Great Lakes Chem.)	935.49	C21H20Br8O2		-	-
K(2)-176	Tetrabromobisphenol A derivative	TB-60(Tohto Kasei)	1275.37	C33H26Br10O4		-	-
K(2)-202	Tetrabromobisphenol S	EB-400S(Manac)	561.67	C12H6Br4O4S		✓	-
K(2)-206	Bis(3,5-dibromo-4-dibromopropoxyphenyl) sulfone	Nonnene PR-2(Marubishi Oil Chemical)	925.42	C18H14Br8O2S		✓	-
K(2)-258	Brominated aromatic amide	EB-905(Manac)	-	-	-	-	-

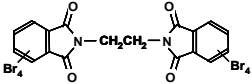
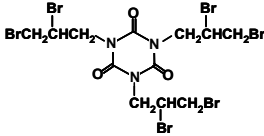
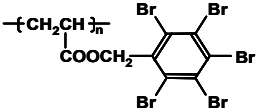
K(2)-262	Ethylenebis(tetrabromophthalimide)	Saytex BT-93(Ethyl Corp.)	943.36	C ₁₈ H ₄ Br ₈ N ₂ O ₄		-	-
K(2)-282	Tris(2,3-dibromopropyl)isocyanurate	AFR-1010(Asahi Glass), FCP-660(Suzuhiro Chemical)	722.62	C ₁₂ H ₁₅ Br ₆ N ₃ O ₃		✓	-
K(2)-318	Brominated aromatic triazine	Pyrogard SR-245(Dai-ichi Kogyo Seiyaku)	-	-	-	-	-
K(2)-622	Poly(pentabromobenzylacrylate)	FR-1025(Dead Sea Bromine)	-	-		-	-
K(2)-665	Brominated epoxy resin	(NOF), Fyrol PCF(Akzo), Antiblaze80(Albright & Wilson)	-	-	-	-	-
K(3)-003	Tris(2-chloroethyl)phosphate	CLP(Daihachi Chemical Industry), TCEP(Nippon chemical industrial), Fyrol CEF(Akzo)	283.95	C ₆ H ₁₂ Cl ₃ O ₄ P	$\text{O}=\text{P}(\text{OCH}_2\text{CH}_2\text{Cl})_3$	-	-
K(3)-008	Tris(2,3-dichloropropyl)phosphate	CRP(Daihachi Chemical Industry), Fyrol FR-2(Akzo)	427.88	C ₉ H ₁₅ Cl ₆ O ₄ P	$\text{O}=\text{P}(\text{OCH}(\text{CH}_2\text{Cl})_2)_3$	-	-
K(3)-028	Tris(tribromoneopentyl)phosphate	CR-900(Daihachi Chemical Industry)	961.42	C ₁₅ H ₂₄ Br ₉ OP	$\text{O}=\text{P}(\text{CH}_2\text{C}(\text{CH}_2\text{Br})_3)_3$	✓	-

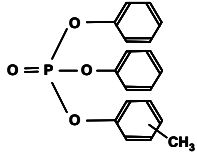
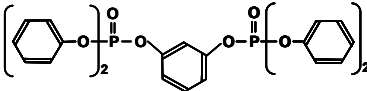
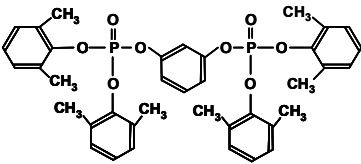
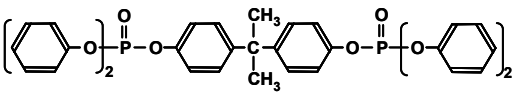
K(3)-080	Chlorinated polyphosphate	CR-509(Daihachi Chemical Industry)	-	-	-	-	-
K(4)-005	Tributyl phosphate	TBP(Daihachi Chemical Industry)	266.16	C ₁₂ H ₂₇ O ₄ P	$\text{O}=\text{P}(\text{OC}_4\text{H}_9)_3$	-	-
K(4)-020	Triphenyl phosphate	TPP(Daihachi Chemical Industry)	326.07	C ₁₈ H ₁₅ O ₄ P	$\text{O}=\text{P}(\text{O}-\text{C}_6\text{H}_5)_3$	-	-
K(4)-021	Cresyl diphenyl phosphate	CDP(Daihachi Chemical Industry), Santicizer 140(Monsanto)	340.09	C ₁₉ H ₁₇ O ₄ P		-	-
K(4)-022	Resorcinol bis(diphenylphosphate)	Reofos RDP(Ajinomoto)	574.09	C ₃₀ H ₂₄ O ₈ P ₂		✓	-
K(4)-023	Tricresyl phosphate	TCP(Daihachi Chemical Industry)	368.12	C ₂₁ H ₂₁ O ₄ P	$\text{O}=\text{P}(\text{O}-\text{C}_6\text{H}_4\text{CH}_3)_3$	-	-
K(4)-024	1,3-Phenylene bis(dixylenyl)phosphate	ADK STAB FP-500(Adeka)	686.22	C ₃₈ H ₄₀ O ₈ P ₂		✓	-
K(4)-026	Bisphenol A bis(diphenylphosphate)	Reofos BAPP(Ajinomoto)	692.17	C ₃₉ H ₃₄ O ₈ P ₂		✓	-

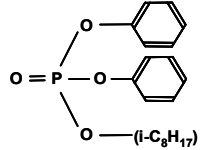
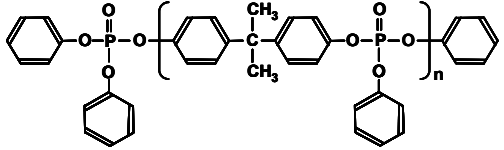
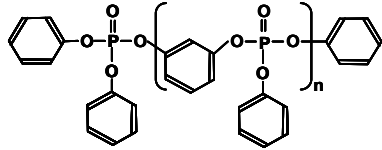
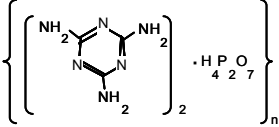
K(4)-045	2-Ethylhexyl diphenyl phosphate	#41(Daihachi Chemical Industry), Santicizer 141(Monsanto)	362.16	C ₂₀ H ₂₇ O ₄ P		-	-
K(4)-080	Aromatic polyphosphate	PX-200, -201, -202(Daihachi Chemical Industry)	-	-	-	-	-
K(4)-081	Condensation products of 2,2-bis(p-hydroxyphenyl)propane and trichlorophosphine oxide	ADK STAB FP-700(Adeka)	-	-		-	-
K(4)-083	Reaction products of following compounds: (1) Condensation products of 1,3-dihydroxybenzene and trichloropropane oxide (n=1 ~ 3) (2) phenol	ADK STAB PFR(Adeka)	-	-		-	-
K(5)-005	Melamine pyrophosphate	-	-	-		-	-

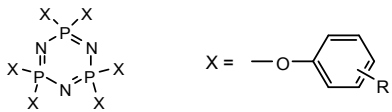
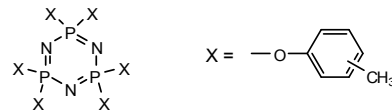
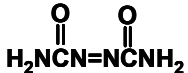
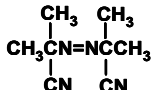
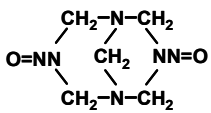
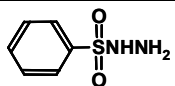
K(6)-102	Oligomer of phosphazene	SPS-100(Otsuka Chemical)	-	-		-	✓
K(6)-104	Oligomer of methylated phosphazene	SPB-100L(Otsuka Chemical)	777.23	C42H42N3O6P3		-	✓
L(2)-001	Azodicarbonamide	Vinyfor AC(Eiwa Chemical Ind.), Unifoam AZ(Otsuka Chemical), Celmike C(Sankyo Kasei), Azobis CA(Nippon Carbide Industries), (Japan Finechem), Celogen AZ(Uniroyal Chem), Polofof ADC(Bayer)	116.03	C2H4N4O2		-	-
L(2)-002	Azobisisobutyronitrile	Vinyfor AZ(Eiwa Chemical Ind.), AIBN(Otsuka Chemical), ABN-S (Japan Finechem)	164.11	C8H12N4		-	-
L(3)-001	N,N'-Dinitrosopentamethylene tetramine	Cellular D(Eiwa Chemical Ind.), Celmike D(Sankyo Kasei), Vulcacef BN 94(Vulnax)	186.09	C5H10N6O2		-	-
L(4)-001	Benzenesulfonyl hydrazide	Celogen BSH(Uniroyal Chem.), Porofof BSH(Bayer)	172.03	C6H8N2O2S		✓	-

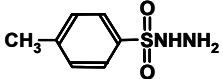
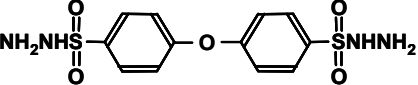
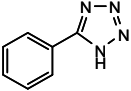
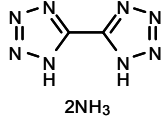
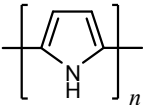
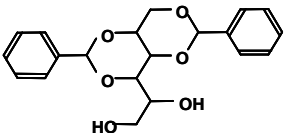
L(4)-002	Toluenesulfonyl hydrazide	Celmike H(Sankyo Kasei), Celogen TSH(Uniroyal Chem.), Profer TSH(Bayer)	186.23	C7H10N2O2S		✓	-
L(4)-003	4,4'-Oxybis(benzenesulfonyl hydrazide)	Neocellborn(Eiwa Chemical Ind.), Celmike S(Sankyo Kasei), Profer DO(Bayer), Celogen OT(Uniroyal Chem.)	358.04	C12H14N4O5S2		✓	-
L(5)-010	5-Phenyltetrazole	CELLTETRA P5T(Eiwa Chemical Ind.)	146.06	C7H6N4		-	✓
L(5)-014	Bistetrazole diammonium	CELLTETRA BHT-2NH3(Eiwa Chemical Ind.)	172.09	C2H8N10		-	✓
N(7)-005	Polypyrrole (solvent: MEK)	-	-	(C4H3N)n		-	✓
O(1)-001	Dibenzylidene sorbitol	EC-1(EC Chemical), (New Japan Chemical), (Marubishi Oil Chemical), Millad 3905(Miliken Chemical)	358.14	C20H22O6		✓	-

O(1)-003	Bis(4-methylbenzylidene) sorbitol	-	386.17	C22H26O6		✓	-
O(1)-004	Bis(dimethylbenzylidene) sorbitol	-	414.49	C24H30O6		✓	-
O(1)-007	Bis(4-ethylbenzylidene) sorbitol	-	414.49	C24H30O6		✓	-
O(1)-010	1,3:2,4-Bis-O-(3,4-dimethylbenzylidene)-D-sorbitol	Millad 3988(Miliken Chemical)	414.49	C24H30O6		✓	-
O(2)-001	Sodium benzoate	-	144.02	C7H5NaO2		-	-
O(2)-005	Aluminum <i>p</i> - <i>t</i> -butyl benzoate	PTBBA-Al(Shell)	558.64	C33H39AlO6		-	-
O(2)-225	Partial metal salt of disproportionated rosin	PINECRISTAL KR-50M (Arakawa Chemical Industries)	-	-		-	✓

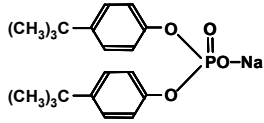
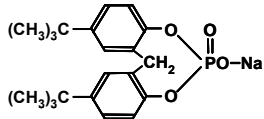
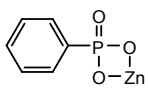
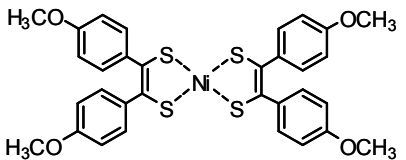
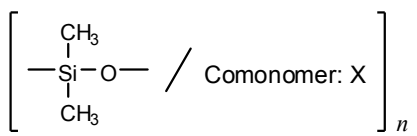
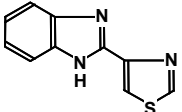
O(3)-003	Sodium bis(4- <i>t</i> -butylphenyl)phosphate	ADK STAB NA10(Adeka)	384.15	C ₂₀ H ₂₆ NaO ₄ P		-	-
O(3)-007	Sodium 2,2'-ethyldiene-bis(4,6-di- <i>t</i> -butylphenyl)phosphate	ADK STAB NA11(Adeka)	396.15	C ₂₁ H ₂₆ NaO ₄ P		-	-
O(3)-102	Phenylphosphonic acid zinc salt	ECOPROMOTE(Nissan Chemical Industries)	219.93	C ₆ H ₅ O ₃ PZn		-	✓
O(3)-800	Organic phosphate complex	ADK STAB NA21(Adeka)	-	-	-	-	-
P(2)-204	Bis(4,4'-dimethoxydithiobenzyl)nickel	MIR-102	662.02	C ₃₂ H ₂₈ O ₄ S ₄ Ni		-	✓
P(4)-384	Crosslinked silicone powder (Copolymer of dimethylpolysiloxane); composite	KMP-605(Shin-Etsu Chemical)	-	-		-	✓
Q(1)-001	Thiabendazole	Metasol TK-100	201.04	C ₁₀ H ₇ N ₃ S		-	-

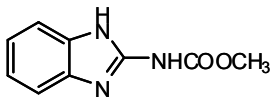
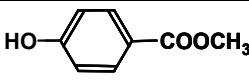
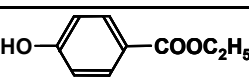
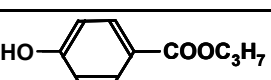
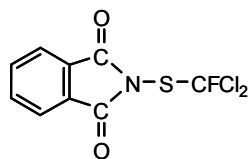
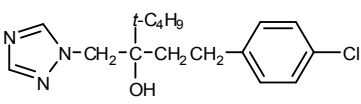
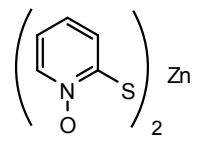
Q(1)-004	2-(Methoxy-carbonylamino)-benzimidazole	Preventol BCM(Lanxess)	191.07	C ₉ H ₉ N ₃ O ₂		-	✓
Q(1)-046	Methyl <i>p</i> -hydroxybenzoate	-	152.05	C ₈ H ₈ O ₃		-	-
Q(1)-047	Ethyl <i>p</i> -hydroxybenzoate	-	166.06	C ₉ H ₁₀ O ₃		-	-
Q(1)-048	Propyl <i>p</i> -hydroxybenzoate	-	180.08	C ₁₀ H ₁₂ O ₃		-	-
Q(1)-062	<i>N</i> -[(Dichlorofluoromethyl)thio]phthalimide	Preventol A 3(Lanxess)	278.93	C ₉ H ₄ NO ₂ FCl ₂ S		-	✓
Q(1)-074	2- <i>tert</i> -Butyl-4-(4-chlorophenyl)-1-(1,2,4-triazol-1-yl)-2-butanol	Preventol A 8(Lanxess)	307.14	C ₁₆ H ₂₂ N ₃ OCl		-	✓
Q(1)-082	Pyrithione zinc	Tomicide ZPT-100(API Corp.), Zinc Omadine(Arch Chem.)	315.93	C ₁₀ H ₈ N ₂ O ₂ S ₂ Zn		-	✓

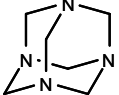
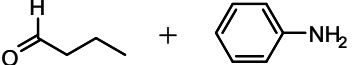
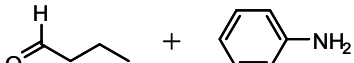
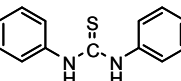
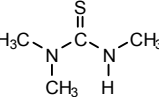
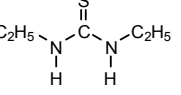
R(1)-402	Crosslinked silicone powder (Copolymer of dimethylpolysiloxane); sphere	KMP-597(Shin-Etsu Chemical)	-	-	$\left[\begin{array}{c} \text{CH}_3 \\ \\ \text{---Si---O---} \\ \\ \text{CH}_3 \end{array} / \text{Comonomer: X} \right]_n$	-	✓
V(1)-001	Hexamethylenetetramine	SANCELER H(Sanshin Chemical Industry), Vulkacit H-30(Bayer)	140.11	C6H12N4		✓	✓
V(1)-002	<i>n</i> -Butylaldehyde-aniline reaction products	Beutene(Uniroyal Chem), Vanax 808(Vanderbilt)	-	-	Reaction products of 	✓	✓
V(1)-003	<i>n</i> -Butylaldehyde-aniline reaction products	-	-	-	Reaction products of 	✓	✓
V(1)-004	<i>N,N'</i> -Diphenylthiourea	Thiocarbanilido(Amm. Cyanamid), Rhenogran DPTU-80(Rhein Chemie)	228.07	C13H12N2S		✓	✓
V(1)-005	Trimethylthiourea	SANCELER TMU(Sanshin Chemical Industry), Thiate EF-2(Kawaguchi Chemical Industry)	118.06	C4H10N2S		✓	✓
V(1)-006	<i>N,N'</i> -Diethylthiourea	Accel EUR(Kawaguchi Chemical Industry), SANCELER EUR(Sanshin Chemical Industry), Thiate H(Vanderbilt)	132.07	C5H12N2S		✓	✓

V(1)-007	1,3-Diphenylguanidine	Accel D(Kawaguchi Chemical Industry), SANCELER D(Sanshin Chemical Industry), SOXINOL D(Sumitomo Chemical), Vanax DPG(Vanderbilt), Vulkacit D(Bayer)	211.11	C13H13N3		✓	✓
V(1)-008	1,3-Di- <i>o</i> -tolylguanidine	SANCELER DT(Sanshin Chemical Industry), SOXINOL DT(Sumitomo Chemical), Vanax DOTG(Vanderbilt)	239.14	C15H17N3		✓	✓
V(1)-009	1- (<i>o</i> -Tolyl)biguanide	-	191.12	C9H13N5		✓	✓
V(1)-010	Dicatechol borate 1,3-di- (<i>o</i> -tolyl)-guanidine salt	Vanax PML(Vanderbilt)	467.2	C27H26N3O4B		✓	✓
V(1)-011	2-Mercaptobenzothiazole	Accel M(Kawaguchi Chemical Industry), SANCELER M(Sanshin Chemical Industry), SOXINOL M(Sumitomo Chemical)	166.99	C7H5NS2		✓	✓

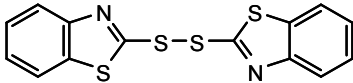
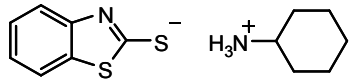
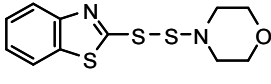
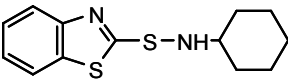
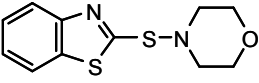
V(1)-012	Di-2-benzothiazolyl disulfide	Accel DM(Kawaguchi Chemical Industry), SANCELER DM(Sanshin Chemical Industry), SOXINOL DM(Sumitomo Chemical)	331.96	C14H8N2S4		✓	✓
V(1)-013	2-Mercaptobenzothiazole cyclohexylamine salt	SANCELER HM(Sanshin Chemical Industry)	266.09	C13H18N2S2		✓	✓
V(1)-014	4-(2-Benzothiazolylidithio)morpholine	Accel DS(Kawaguchi Chemical Industry)	284.01	C11H12N2OS3		✓	✓
V(1)-015	N-Cyclohexyl-2-benzothiazolylsulfenamide	Accel CZ(Kawaguchi Chemical Industry), SANCELER CM(Sanshin Chemical Industry), SOXINOL CZ(Sumitomo Chemical)	264.08	C13H16N2S2		✓	✓
V(1)-016	2-(Morpholiniothio)benzothiazole	Accel NS(Kawaguchi Chemical Industry), SANCELER NOB(Sanshin Chemical Industry), SOXINOL NBS-G(Sumitomo Chemical)	252.04	C11H12N2OS2		✓	✓

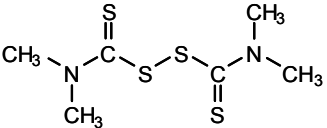
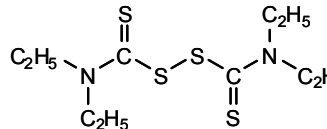
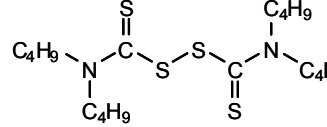
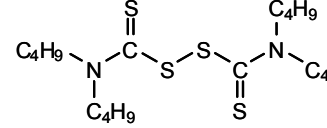
V(1)-017	Tetramethylthiuram disulfide	Accel TMT(Kawaguchi Chemical Industry), SANCELER TT(Sanshin Chemical Industry), SOXINOL TT(Sumitomo Chemical)	239.99	C6H12N2S4		✓	✓
V(1)-018	Bis (diethylthiocarbamoyl) disulfide	Accel TET(Kawaguchi Chemical Industry), SANCELER TET(Sanshin Chemical Industry), SOXINOL TET(Sumitomo Chemical)	296.05	C10H20N2S4		✓	✓
V(1)-019	Tetrabutylthiuram disulfide	Accel TBT(Kawaguchi Chemical Industry), SANCELER TBT(Sanshin Chemical Industry), SOXINOL TBT(Sumitomo Chemical)	408.18	C18H36N2S4		✓	✓
V(1)-020	Tetrabutylthiuram disulfide	-	408.18	C18H36N2S4		✓	✓

V(1)-021	Tetrakis (2-ethylhexyl)thiuram disulfide	-	632.43	C ₃₄ H ₆₈ N ₂ S ₄		✓	✓
V(1)-022	Tetramethylthiuram monosulfide	Accel TS(Kawaguchi Chemical Industry), SANCELER TS(Sanshin Chemical Industry), SOXINOL TS(Sumitomo Chemical)	208.02	C ₆ H ₁₂ N ₂ S ₃		✓	✓
V(1)-023	Dipentamethylenethiuram tetrasulfide	Accel TRA(Kawaguchi Chemical Industry), SANCELER TRA(Sanshin Chemical Industry), SOXINOL TRA(Sumitomo Chemical)	383.99	C ₁₂ H ₂₀ N ₂ S ₆		✓	✓
V(1)-024	Piperidinium pentamethylenedithiocarbamate	Accel PP(Kawaguchi Chemical Industry), Robac PPD(Robinson Brothers), Vanax 552(Vanderbilt)	246.12	C ₁₁ H ₂₂ N ₂ S ₂		✓	✓

V(1)-025	Zinc (II) dimethyldithiocarbamate	Accel PZ(Kawaguchi Chemical Industry), SANCELER PZ(Sanshin Chemical Industry), SOXINOL PZ(Sumitomo Chemical), Cyzate M(Amm. Cya.)	303.92	C ₆ H ₁₂ N ₂ S ₄ Zn		✓	✓
V(1)-026	Zinc (II) diethyldithiocarbamate	Accel EZ(Kawaguchi Chemical Industry), SANCELER EZ(Sanshin Chemical Industry), SOXINOL EZ(Sumitomo Chemical)	359.98	C ₁₀ H ₂₀ N ₂ S ₄ Zn		✓	✓
V(1)-027	Zinc (II) dibutyldithiocarbamate	Accel BZ(Kawaguchi Chemical Industry), SANCELER BZ(Sanshin Chemical Industry), SOXINOL BZ(Sumitomo Chemical)	472.1	C ₁₈ H ₃₆ N ₂ S ₄ Zn		✓	✓
V(1)-028	Zinc (II) di (N-ethyl-N-phenyldithiocarbamate)	Accel PX(Kawaguchi Chemical Industry), SANCELER PX(Sanshin Chemical Industry), SOXINOL PX(Sumitomo Chemical)	455.98	C ₁₈ H ₂₀ N ₂ S ₄ Zn		✓	✓

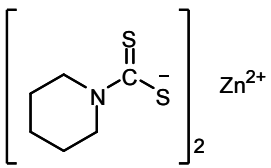
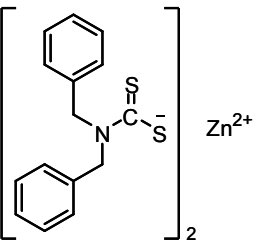
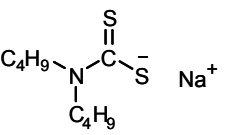
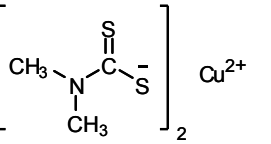
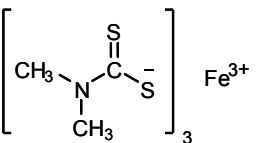
V(1)-029	Zinc (II) dipiperidine-1-carbodithioate	Robac ZPD(Robinson Brothers)	383.98	C ₁₂ H ₂₀ N ₂ S ₄ Zn		✓	✓
V(1)-030	Zinc (II) dibenzylidithiocarbamate	Arazate(Uniroyal Chem.), Robac ZBEc(Robinson Brothers), Perkacit ZBEC(Akzo Chemie)	608.04	C ₃₀ H ₂₈ N ₂ S ₄ Zn		✓	✓
V(1)-031	Dibutylcarbamo-dithioic acid sodium salt	Accel TP(Kawaguchi Chemical Industry), Perkacit SDPC(Akzo Chemie)	227.08	C ₉ H ₁₈ NNaS ₂		✓	✓
V(1)-032	Copper (II) dimethyldithiocarbamate	SANCELER TTCU(Sanshin Chemical Industry), Methyl Cumate(Vanderbilt), Perkacit CDMC(Akzo Chemie)	302.92	C ₆ H ₁₂ N ₂ S ₄ Cu		✓	✓
V(1)-033	Iron (III) dimethyldithiocarbamate	SANCELER TT-Fe(Sanshin Chemical Industry)	415.92	C ₉ H ₁₈ N ₃ S ₆ Fe		✓	✓

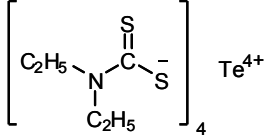
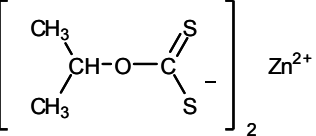
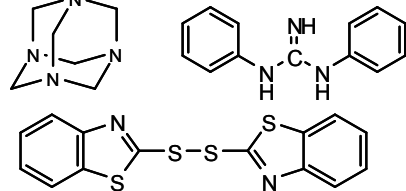
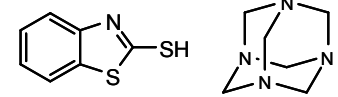
V(1)-034	Tellurium diethyldithiocarbamate	Accel TL-PT(Kawaguchi Chemical Industry), SANCELER TE-G(Sanshin Chemical Industry), SOXINOL TE-G(Sumitomo Chemical)	722.01	C ₂₀ H ₄₀ N ₄ S ₈ Te		✓	✓
V(1)-035	Zinc (II) isopropyl xanthate	SANCELER ZS(Sanshin Chemical Industry), Propyl Zithate(Vanderbilt), Robac ZIS(Pennwalt)	333.92	C ₈ H ₁₄ O ₂ S ₄ Zn		✓	✓
V(1)-036	Mixtures of di-2-benzothiazolyl disulfide, 1,3-diphenylguanidine and hexamethylenetetramine	SANCELER F(Sanshin Chemical Industry), Accel F(Kawaguchi Chemical Industry)	331.96, 211.11, 140.11	C ₁₄ H ₈ N ₂ S ₄ , C ₁₃ H ₁₃ N ₃ , C ₆ H ₁₂ N ₄		✓	✓
V(1)-037	Mixtures of 2-mercaptobenzothiazole and hexamethylenetetramine	SANCELER FX-1(Sanshin Chemical Industry)	166.99, 140.11	C ₇ H ₅ NS ₂ , C ₆ H ₁₂ N ₄		✓	✓

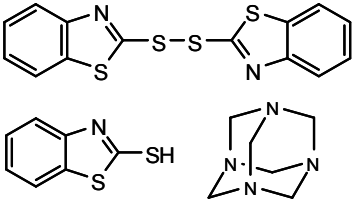
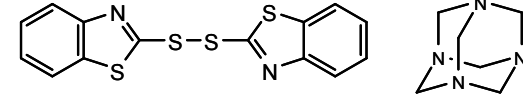
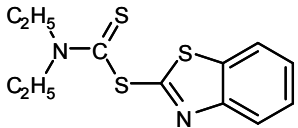
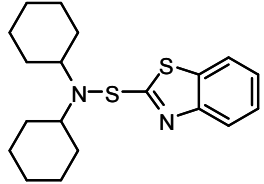
V(1)-038	Mixtures of 2-mercaptobenzothiazole, di-2-benzothiazolyl disulfide and hexamethylenetetramine	SANCELER FX-3(Sanshin Chemical Industry)	166.99, 331.96, 140.11	C7H5NS2, C14H8N2S4, C6H12N4		✓	✓
V(1)-039	Mixtures of di-2-benzothiazolyl disulfide and hexamethylenetetramine	SANCELER FX-2(Sanshin Chemical Industry)	331.96, 140.11	C14H8N2S4, C6H12N4		✓	✓
V(1)-043	2-Benzothiazolyl diethyldithiocarbamate	Ethylac(Pennwalt)	282.03	C12H14N2S3		✓	✓
V(1)-044	<i>N,N</i> -Dicyclohexyl-2-benzothiazolesulfenamide	Accel DZ-G(Kawaguchi Chemical Industry), SANCELER DZ(Sanshin Chemical Industry), Vulcafor DCBS(Vulnax)	346.15	C19H26N2S2		✓	✓

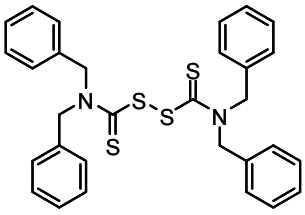
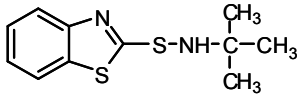
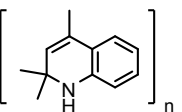
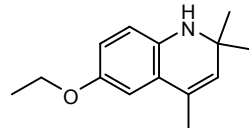
V(1)-045	Tetrabenzylthiuram disulfide	SANCELER TBZTD(Sanshin Chemical Industry)	544.11	C30H28N2S4		✓	✓
V(1)-046	<i>N-tert</i> -Butyl-2-benzothiazolesulfenamide	Accel BNS-R(Kawaguchi Chemical Industry), SANCELER NS(Sanshin Chemical Industry), Pennac TBBS(Pennwalt)	238.06	C11H14N2S2		✓	✓
W(1)-001	Polymerized 2,2,4-trimethyl-1,2-dihydroquinoline	Nocrac 224(Ouchishinko Chemical Industrial), Nonflex QS(Seiko Chemical), Antage RD(Kawaguchi Chemical Industry)	-	-		-	-
W(1)-002	6-Ethoxy-1,2-dihydro-2,2,4-trimethylquinoline	Nocrac AW(Ouchishinko Chemical Industrial), Nonflex AW(Seiko Chemical), Antage AW(Kawaguchi Chemical Industry)	217.15	C14H19NO		-	-
W(1)-003	Reaction product of diphenylamine and acetone	Nocrac B(Ouchishinko Chemical Industrial), Nonflex BA(Seiko Chemical)	-	-	-	-	-

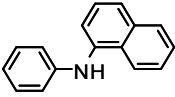
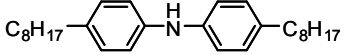
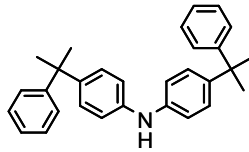
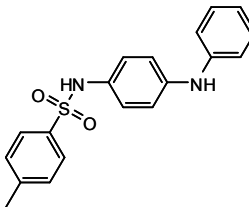
W(1)-004	Reaction product of diphenylamine, aniline and acetone	Nonflex BA-R(Seiko Chemical)	-	-	-	-	-
W(1)-005	Reaction product of amine and acetone	Nonflex RD(Seiko Chemical)	-	-	-	-	-
W(1)-006	Phenyl-1-naphthylamine	Nocrac PA(Ouchishinko Chemical Industrial)	219.10	C16H13N		-	-
W(1)-007	Alkylated diphenylamine	Nocrac ODA(Ouchishinko Chemical Industrial)	-	-	-	-	-
W(1)-008	Octylated diphenylamine	Nocrac AD-F(Ouchishinko Chemical Industrial), Nonflex OD-3(Seiko Chemical)	393.34	C28H43N		-	-
W(1)-009	4,4'-Bis(alpha,alpha-dimethylbenzyl)diphenylamine	Nocrac CD(Ouchishinko Chemical Industrial), Nonflex DCD(Seiko Chemical)	405.24	C30H31N		-	-
W(1)-010	p-(p-Toluene sulfonylamido)diphenylamine	Nocrac TD(Ouchishinko Chemical Industrial)	338.11	C19H18N2O2S		-	-

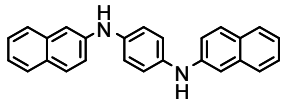
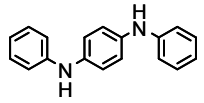
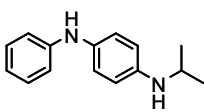
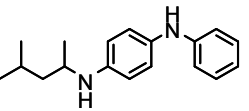
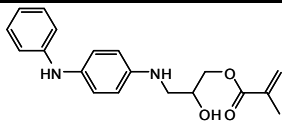
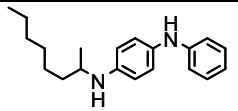
W(1)-011	<i>N,N'</i> -Di-2-naphthyl- <i>p</i> -phenylenediamine	Nocrac White(Ouchishinko Chemical Industrial), Nonflex F(Seiko Chemical)	360.16	C ₂₆ H ₂₀ N ₂		-	-
W(1)-012	<i>N,N'</i> -Diphenyl- <i>p</i> -phenylenediamine	Nocrac DP(Ouchishinko Chemical Industrial), Nonflex H(Seiko Chemical)	260.13	C ₁₈ H ₁₆ N ₂		-	-
W(1)-013	<i>N</i> -Phenyl- <i>N'</i> -isopropyl- <i>p</i> -phenylenediamine	Nocrac 810-NA(Ouchishinko Chemical Industrial), Ozonone 3C(Seiko Chemical), Antage 3C(Kawaguchi Chemical Industry)	226.15	C ₁₅ H ₁₈ N ₂		-	-
W(1)-014	<i>N</i> -Phenyl- <i>N'</i> -(1,3-dimethylbutyl)- <i>p</i> -phenylenediamine	Nocrac 6C(Ouchishinko Chemical Industrial), Ozonone 6C(Seiko Chemical), Antage 6C(Kawaguchi Chemical Industry)	268.19	C ₁₈ H ₂₄ N ₂		-	-
W(1)-015	<i>N</i> -phenyl- <i>N'</i> -(3-methacryloyloxy-2-hydroxypropyl)- <i>p</i> -phenylenediamine	Nocrac G-1(Ouchishinko Chemical Industrial)	326.16	C ₁₉ H ₂₂ N ₂ O ₃		-	-
W(1)-016	<i>N</i> -(1-Methylheptyl)- <i>N'</i> -phenyl- <i>p</i> -phenylenediamine	Ozonone 35(Seiko Chemical)	296.22	C ₂₀ H ₂₈ N ₂		-	-

W(1)-017	Mixed diaryl- <i>p</i> -phenylenediamine	Wingstay 100(Eliokem)	-	-	-	-	-
W(1)-018	2,6-Di- <i>tert</i> -butyl-4-methylphenol	Nocrac 200(Ouchishinko Chemical Industrial), BHT Swanox(Seiko Chemical), Antage BHT(Kawaguchi Chemical Industry)	220.18	C ₁₅ H ₂₄ O		-	-
W(1)-019	2,6-Di- <i>tert</i> -butyl-4-ethylphenol	Nocrac M-17(Ouchishinko Chemical Industrial)	234.20	C ₁₆ H ₂₆ O		-	-
W(1)-020	Mono(or di or tri)(alpha-methylbenzyl)phenol	Nocrac SP(Ouchishinko Chemical Industrial), BHT Swanox(Seiko Chemical), Antage BHT(Kawaguchi Chemical Industry)	-	-		-	-
W(1)-021	<i>n</i> -Octadecyl-3-(4-hydroxy-3',5'-di- <i>tert</i> -butylphenyl)propionate	Irganox 1076(Ciba-Geigy)	530.47	C ₃₅ H ₆₂ O ₃		-	-
W(1)-022	2- <i>tert</i> -Butyl-6-(3- <i>tert</i> -butyl-2-hydroxy-5-methylbenzyl)-4-methylphenyl acrylate	-	394.25	C ₂₆ H ₃₄ O ₃		-	-
W(1)-023	4,6-Bis(octylthiomethyl)- <i>o</i> -cresol	Irganox 1520(Ciba-Geigy)	424.28	C ₂₅ H ₄₄ OS ₂		-	-

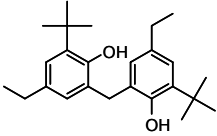
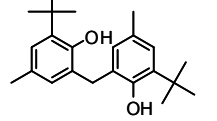
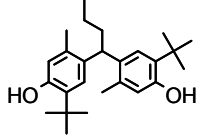
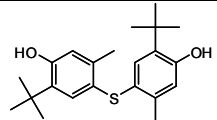
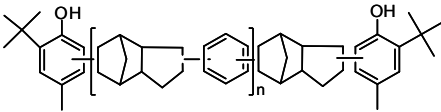
W(1)-024	2,2'-Methylenebis(4-ethyl-6- <i>tert</i> -butylphenol)	Nocrac NS-5(Ouchishinko Chemical Industrial), Nonflex EBP(Seiko Chemical), Antage W-500(Kawaguchi Chemical Industry)	368.55	C25H36O2		-	-
W(1)-025	2,2'-Methylenebis(4-methyl-6- <i>tert</i> -butylphenol)	Nocrac NS-6(Ouchishinko Chemical Industrial), Nonflex MBP(Seiko Chemical), Antage W-400(Kawaguchi Chemical Industry)	340.24	C23H32O2		-	-
W(1)-026	4,4'-Butylidenebis(3-methyl-6- <i>tert</i> -butylphenol)	Nocrac NS-30(Ouchishinko Chemical Industrial), Nonflex BB(Seiko Chemical), Antage W-300(Kawaguchi Chemical Industry)	382.29	C26H38O2		-	-
W(1)-027	4,4'-Thiobis(3-methyl-6- <i>tert</i> -butylphenol)	Nocrac 300(Ouchishinko Chemical Industrial), Nonflex BPS-R(Seiko Chemical), Antage Cryltal(Kawaguchi Chemical Industry)	358.20	C22H30O2S		-	-
W(1)-028	Butylated reaction product of <i>p</i> -cresol and dicyclopentadiene	Nocrac PBK(Ouchishinko Chemical Industrial)	-	-		-	-

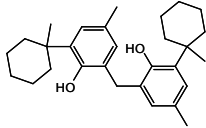
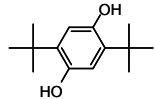
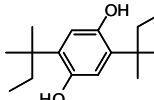
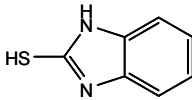
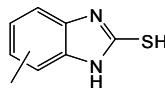
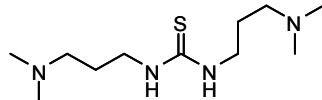
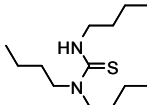
W(1)-029	2,2'-Methylene-bis[6-(1-methylcyclohexyl- <i>p</i> -cresol)]	Nonflex CBP(Seiko Chemical)	420.30	C29H40O2		-	-
W(1)-031	2,5-Di- <i>tert</i> -butylhydroquinone	Nocrac NS-7(Ouchishinko Chemical Industrial), Nonflex Alba(Seiko Chemical), Antage DBH(Kawaguchi Chemical Industry)	222.16	C14H22O2		-	-
W(1)-032	2,5-Di- <i>tert</i> -amylhydroquinone	Nocrac DAH(Ouchishinko Chemical Industrial), Antage DAH(Kawaguchi Chemical Industry)	250.19	C16H26O2		-	-
W(1)-033	2-Mercaptobenzimidazole	Nocrac MB(Ouchishinko Chemical Industrial), Nonflex MB(Seiko Chemical), Antage MB(Kawaguchi Chemical Industry)	150.03	C7H6N2S		-	-
W(1)-034	Methyl-2-mercaptobenzimidazole	Nocrac MMB(Ouchishinko Chemical Industrial)	359.03	C16H15N4SZn		-	-
W(1)-035	1,3-Bis(dimethylaminopropyl)-2-thiourea	Nocrac NS-10-N(Ouchishinko Chemical Industrial)	246.19	C11H26N4S		-	-
W(1)-036	Tributyl thiourea	Nocrac TBTU(Ouchishinko Chemical Industrial)	244.20	C13H28N2S		-	-

W(1)-037	Tris(nonylphenyl) phosphite	Nocrac TNP(Ouchishinko Chemical Industrial), Nonflex TNP(Seiko Chemical)	688.50	C ₄₅ H ₆₉ O ₃ P		-	-
W(1)-038	Dilauryl thiodipropionate	Nocrac 400(Ouchishinko Chemical Industrial)	514.84	C ₃₀ H ₅₈ O ₄ S		-	-
Y(1)-001	Mixture of polycyclic aromatic		-	-	-	-	✓