

Process Micro-chromatograph PGC 490

ATEX explosion-proof rapid gas analyzer

General user manual



SRA INSTRUMENTS
210 rue des Sources
69280 Marcy l'Etoile
FRANCE

T : 04.78.44.29.47
F : 04.78.44.29.62
info@sra-instruments.com
www.sra-instruments.com

SA à Directoire et Conseil de
surveillance au capital de 150.000 €
RCS Lyon B 342 068 731
APE 4669B
SIRET: 342 068 731 00054
Code TVA FR 40342068731



Table of contents

1. INTRODUCTION	4
2. SAFETY INSTRUCTIONS	4
2.1 Important general information	4
2.2 Warnings concerning work in explosive atmosphere	4
2.3 Responsibility for ATEX certification	5
2.4 The manufacturer's badge	5
2.5 Temperature class and admissible temperature	6
3. INSTRUMENT OVERVIEW	7
3.1 Presentation	7
3.2 Operating principle	7
3.3 Inside view of the PGC 490	8
4. SITE PREPARATION	9
4.1 Tools and accessories needed for the installation	9
4.1.1 Tools	9
4.1.2 Accessories	9
4.2 Ventilation	9
4.3 Carrier gases	9
4.4 Gas connection	9
4.4.1 Safety rules for the use of compressed gas cylinders	9
4.4.2 Installation	10
4.4.3 Optimization of gas purity	11
4.4.4 Connections to the analyzer	11
4.4.5 Swagelok fittings	11
4.4.6 Flow limiters	13
5. INSTALLATION	13
5.1 Installation location	13
5.2 Mounting	13
5.3 Closing explosion-proof enclosures	13
5.4 Explosion-proof pneumatic crossings	14
5.5 Electrical connections	14
5.6 Recommendation for cable glands supplied	14



6. STARTING UP	15
6.1 The 4 golden rules	15
6.2 Carrier gas connection	16
6.3 Typical MicroGC Sample lines	17
6.4 Sample release outlets	19
7. START-UP PROCEDURE	19
7.1 Start-up the chromatograph	19
7.2 Launch the software	19
7.3 Load the PURGE method	19
7.4 Load the ANALYSIS method	20
8. STOP PROCEDURE	20
8.1 Short time stops (less than 2 weeks)	21
8.2 Long stops (more than 2 weeks) or PGC moving	21
9. MAINTENANCE	21
10. TECHNICAL DATA	23
10.1 Power supply	24
10.2 Dimensions and weight	24
10.3 Chromatographic modules	24
10.3.1 Carrier gases	24
10.3.2 Sample and injection	24
10.3.3 Injector	24
10.3.4 Column	24
10.3.5 Detector	24
10.3.6 Linear dynamic range	24
10.3.7 Repeatability	24
10.4 Communication	25
10.5 Inputs/Outputs	25
10.6 Driving software	25
10.7 Specific calculation	25
11. EU DECLARATION OF CONFORMITY	26



1. Introduction

For reasons of clarity, this manual does not contain all detailed information on all types of chromatograph. In addition, it cannot describe every possible case concerning installation, use or maintenance.

If you require additional information about this device or if you encounter problems that are not addressed in this manual, you can contact SRA Instruments for assistance.

The content of this manual is not part of any previous or existing agreement, commitment or legal status and does not change these. All the commitments of SRA INSTRUMENTS are contained in the respective sales contracts, which also contain the only and entire applicable warranty terms. These warranty conditions in the contract are neither extended nor limited by the content of this manual.

2. Safety instructions



2.1 Important general information



This instrument is designed for chromatographic analysis of appropriately prepared samples. It must be operated using appropriate gases or solvents and within specified maximum ranges for pressure, flows, and temperatures as described in this manual. If the equipment is used in a manner not specified by SRA Instruments, the protection provided by the equipment may be impaired.

It is the responsibility of the customer to inform SRA Instruments after-sales service if the instrument has been used for the analysis of hazardous samples, prior to any instrument service being performed or when an instrument is being returned for repair.

2.2 Warnings concerning work in explosive atmosphere



The  symbol is used to indicate special instructions regarding protection against explosions.

  The PGC 490 must only be operated by qualified personnel with knowledge of the operating conditions of electrical equipment in explosive atmospheres (ATEX certification).





  Any work on the analyzer must be carried out in strict compliance with the safety requirements:

- It is forbidden to open the box when the power is on.
- It is forbidden to open the box without making sure that the surrounding air does not pose any risk.
- Prohibition for personnel other than SRA Instruments to work on electronic boards.

  Any modification of the PGC 490 is prohibited without written authorization from SRA Instruments.

  PGC 490 components can only be replaced by SRA Instruments.



-   The enclosure casing must be earthed by a cable with a cross-section greater than 4 mm².
-   Installation and maintenance must comply with NF EN 60079-14, NF EN 60079-17 and NF EN 60079-19 standards.

Installation and maintenance of PGC 490 must be carried out by authorized persons, in accordance with the recommendations listed in this manual.

2.3 Responsibility for ATEX certification

SRA Instruments accepts liability only for the materials and equipment delivered, selected in accordance with the data on operating conditions, information provided by the customer or end user and confirmed in the order confirmation.

All other assembled equipment must have a separate certification issued by the equipment supplier. The latter must have the same or a higher degree of protection than the μ PGC.

The μ PGC manufacturer's badge is riveted to the front of the analyzer.

Similarly, auxiliary equipment must have their manufacturer's badge.

2.4 The manufacturer's badge



The manufacturer's badge information is as follows:

 : CE marking

0081: Reference number of the notified body which issued the Quality Assurance Notification, in this case LCIE

LCIE 17 ATEX 3064 X: EU type-examination certificate number issued by LCIE

II 2 G Ex db IIC T5 Gb: gas marking

- **II** = Equipment group (I = Mining, II = Surface industries)
- **2** = Equipment category (2 = frequent risk zone 1 and 21)
- **G** = Gases, vapors (D = dust)
- **Ex** = The equipment meets the CENELEC protection standards for electrical equipment
- **d** = Type of protection: explosion proof
- **b** = The index b corresponds to the protection level (EPL) Gb
- **IIC** = Most severe gas group including hydrogen, acetylene and carbon bisulfide
- **T5** = Temperature class corresponding to an environment whose self-ignition temperature is higher than 100 °C.
- **Gb** = Equipment protection level

2.5 Temperature class and admissible temperature

Equipment intended for use in explosive atmospheres is classified according to the maximum surface temperature it generates.

In normal operation of the PGC 490, the maximum surface temperature of the explosion-proof enclosures (analysis box and junction box) must be less than 100 °C (maximum surface temperature allowed by the temperature class T5 of the analyzer).

It is then up to the user to verify that the self-ignition temperature of the atmosphere is above 100 °C.

The temperature class of a material is only valid for a given operating ambient temperature (or a given operating temperature range).

In the case of PGC 490, the ambient temperature "Tamb" must be within the scale:

$$- 40 \text{ °C} < T_{amb} < + 55 \text{ °C}.$$

Otherwise, the actual ambient temperature will be indicated on the manufacturer's badge.



3. Instrument overview

3.1 Presentation

The PGC 490 is a process micro-chromatograph for on-line gas and vapor analysis in most industrial environments. The PGC 490 has an explosion-proof outer cover and is designed for installation in hazardous areas and outdoors.

In some cases, the PGC 490 can be used as a sensor in a process control loop.



3.2 Operating principle

The PGC 490 can be equipped with 1 to 3 independent column channels. Each column channel is a miniaturized and complete GC, including:

- A micro-machined injector
 - An analytical column of small diameter
 - A universal detector (micro TCD)
 - An electronic gas control
- } **Module**



The analytical channels of the PGC 490 can optionally be equipped with a backflush. It has the advantage of protecting the stationary column phase against moisture and carbon dioxide. Moreover, the analysis times are reduced since the components with late elution, thus not presenting interest, do not enter the analytical column.

3.3 Inside view of the PGC 490

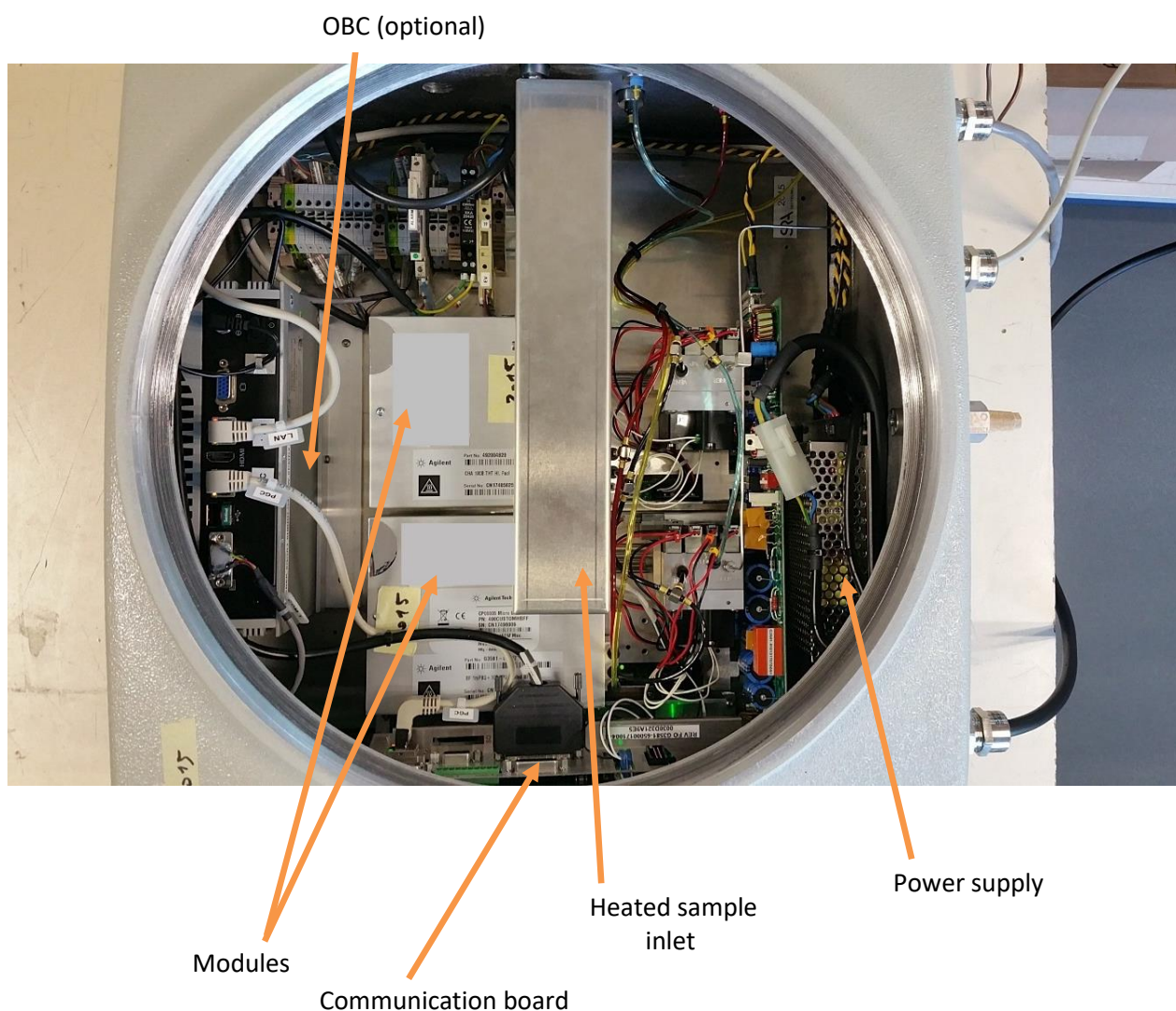

4. Site preparation

4.1 Tools and accessories needed for the installation

4.1.1 Tools

- 1/8" preconditioned copper or stainless-steel tubing for carrier gas connection
- 1/8" Swagelok® nuts, and front and back ferrules
- 1/8" preconditioned stainless-steel tubing for sample connection
- 1/8" Swagelok® nuts, and front and back ferrules
- Two 7/16" wrenches
- A 5/16" wrench

4.1.2 Accessories

Electronic leak detector (optional).

4.2 Ventilation

To optimize the performance of the analyzer and increase its service life, allow sufficient air circulation around the analyzer to dissipate heat and eliminate the release of potentially toxic, noxious or flammable carrier gases or samples. If necessary, toxic discharges can be trapped.

Avoid discharging gaseous effluents into an area that may experience pressure fluctuations (wind or releases with variable temperature). Changes in pressure can affect the stability of the baseline and the sensitivity of the analyzer.

4.3 Carrier gases

A continuous, controlled flow of carrier gas before and during the analysis is necessary. SRA Instruments recommends "instrument" or "chromatographic" purity grades of gases specifically intended for chromatographic use.

Generally speaking, the gases used must have a purity of at least 99.9996 % with a very low concentration (< 0.5 ppm) in oxygen and total hydrocarbons.

- Helium is the preferred carrier gas for standard applications, but the instrument is also compatible with nitrogen and argon.
- Use 1/8" Swagelok® fittings for connections. 1/4" on request.

4.4 Gas connection

4.4.1 Safety rules for the use of compressed gas cylinders

- Secure all compressed gas cylinders to a fixed element or directly to the wall. Store and handle these cylinders in accordance with safety regulations.
- Do not store gas cylinders in a transit area or near a heat source.
- To avoid possible injury, wear safety glasses when using pressurized gases.



4.4.2 Installation

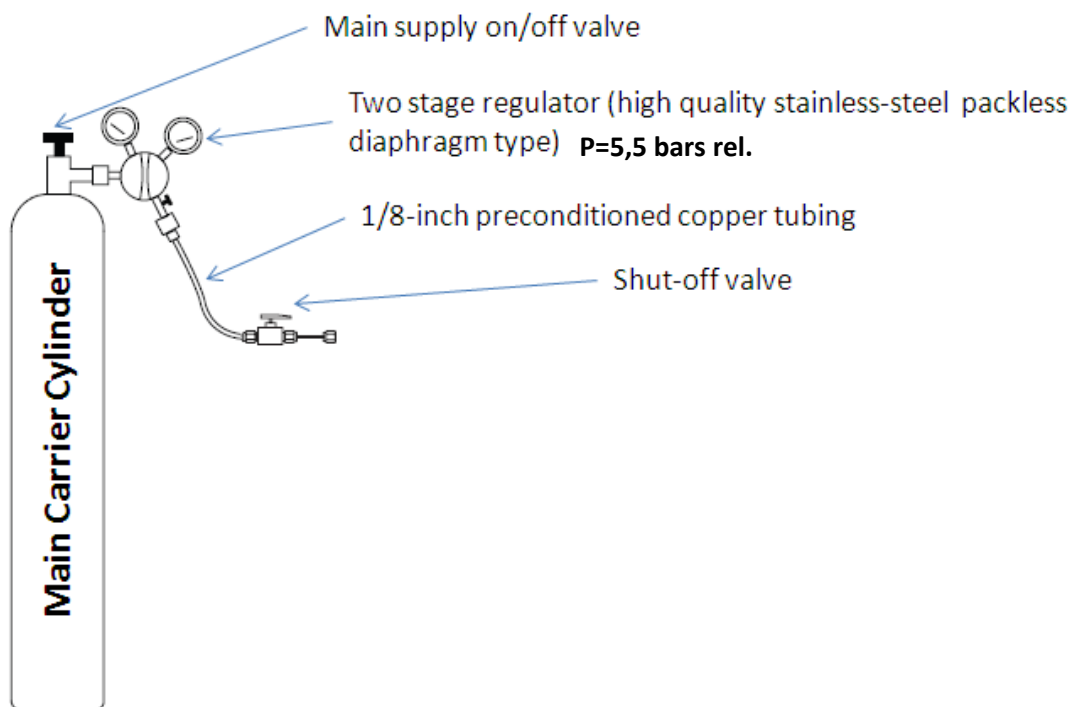

Set your input pressure between [530 and 570 kPa] [77 and 83 psi] [5.3 and 5.7 bars]

Whenever the cylinder is changed, take care to purge the pressure reducer correctly to avoid contaminating the distribution circuit with air.

Tubing

Do not use ordinary copper tubes: they contain traces of oil and contaminants.

Do not use plastic tubing to supply gas to the instrument : it is permeable to oxygen and other contaminants that can damage the columns and detectors. In addition, these tubes can melt if they are near a heat source.

The diameter of the tubes depends on the distance between the gas cylinder and the analyzer and the total flow required. A 1/8" tube is adequate when the supply line is less than 4.6 m long. Use a larger diameter tube (1/4") for distances greater than 4.6 m or when multiple instruments are connected to the same source.

Plan wide by installing a gas inlet: a few extra tube windings will allow the analyzer to move without having to change the gas distribution.

Do not use sealings: they may contain volatile materials that could contaminate the distribution circuit.

Do not use a liquid leak detector: liquid may contaminate the tube. Prefer the use of an electronic leak detector.



4.4.3 Optimization of gas purity

To have the best possible carrier gas quality on your analyzer, SRA Instruments recommends :

- Use a carrier gas purity of at least 99.9996%.
- Add carrier gas filters (oxygen, humidity and hydrocarbons).
- Use a suitable pressure reducer.
- Use suitable connection tubes and ferrules.
- Correctly purge dead volumes before connecting the tube to your analyzer.
- Confirm that there are no leaks in your assembly with an electronic leak detector.
- Always download a purge method (with TCD OFF) to purge the internal volumes and the column BEFORE setting the detector ON.

4.4.4 Connections to the analyzer

The analyzer uses 1/8" Swagelok® fittings for the carrier gas inlet. A set containing a 1/8" Swagelok® nut and ferrule is required to connect to each fitting. A 1/4" or 6 mm diameter is available on request.

The MicroGC uses 1/8" Swagelok® fittings for low-pressure gases (column and sample vents) except special request.

Gas lines

- Material: stainless steel (1/8"). Only use extremely clean gas lines. Clean them if necessary prior to assembly or use new tubing pre-cleaned.
- Connect the gas lines to the chromatograph according to the distribution diagram. You can connect a shut-off valve to each flow arriving at the chromatograph.

Gas connections on the chromatograph

- All carrier gas inlets : 1/8" Swagelok® - 1/4" on request
- All sample inlets: 1/8" Swagelok® - 1/4" on request

4.4.5 Swagelok fittings

The gas supply tubing is attached with Swagelok fittings. If you are not familiar with making Swagelok connections, review the following procedure. The procedure explains how to connect tubing to a fitting, such as inlet and detector manifolds or the gas supply tank.

Material needed:

- 1/8" (or 1/4", if used) preconditioned copper tubing
- 1/8" (or 1/4", if used) Swagelok® nuts, and front and back ferrules
- Two 7/16 " wrenches (or 9/16 " if 1/4")

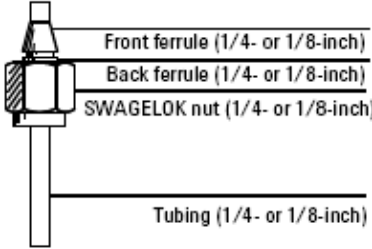
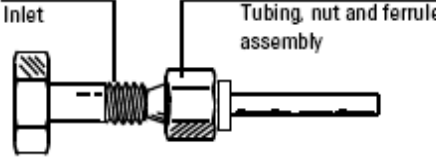
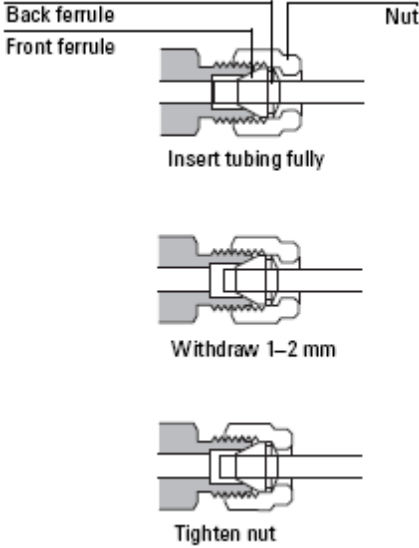
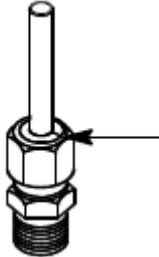
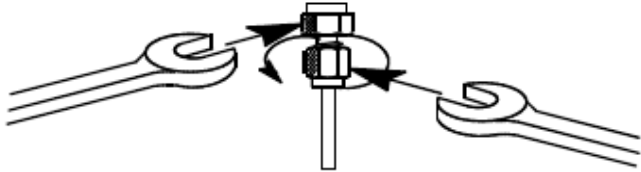

<p>Place a 1/8" Swagelok® nut, rear ferrule, and front ferrule on the tube.</p>	
<p>Make sure the ferrule is in contact with the inlet. Then slide the Swagelok® nut over the ferrule and tighten by hand.</p>	
<p>Insert the tube as far as possible into the female part, then remove it from 1 to 2 mm.</p>	
<p>Mark the position of the nut with a pencil.</p>	
<p>If using 1/8" Swagelok® fittings, use 2 7/16" wrenches: hold the fitting with one wrench while tightening the fitting of 3/4 turn with the other.</p> <p>If using 1/4" fittings, use 2 9/16" wrenches. In this case, clamping requires 1.25 turns.</p>	



4.4.6 Flow limiters

In accordance with annex G of standard NF EN 60079-1:2014 on explosive atmospheres, flow limiters specially sized for the analyzer are installed at each gas inlet.



To maintain certification of the instrument, these limiters must not be removed or modified under any circumstances .

5. Installation

The installation must comply with standard **NF EN 60079-14** (Explosive atmospheres - Part 14: Design, selection and construction of electrical installations).

5.1 Installation location

The PGC 490 can be installed in explosive atmospheres (surface industries). It complies with the 2014/34/EU ATEX Directive.

The surface temperature of the explosion-proof enclosures of the analyzers must not exceed 100 °C within an ambient temperature range of - 40 °C to + 55 °C.

Nevertheless, we will make sure to install them sheltered from the bad weather and the sun.

For correct operation, it is recommended not to use the analyzer at an ambient temperature below 0 °C.

5.2 Mounting

Either the analyzer is delivered on a carrier frame or it can be mounted on a wall.

Explosion-proof enclosures shall be protected against impact.

No drilling or machining operations must be carried out. No items not listed in the certification file may be installed inside the explosion-proof enclosures.

5.3 Closing explosion-proof enclosures

Safety is only guaranteed when the main box cover and the junction box cover are completely screwed and capped.

- Turn the covers clockwise.
- Ensure perfect tightness by using a metal rod centered in both ears of the cover (a gap of about 0.5 mm remains with the housing).
- Do not forget to lock the covers using the screw provided for this purpose, located on the periphery of the covers. The screw should only be screwed in until contact is made.
- The mention "**DO NOT OPEN WHILE ENERGIZED**" must be respected before any intervention on the equipment. This precaution is indicated in red characters on the manufacturer's badge riveted to the front of the analyzer.



The same applies to the explosion-proof switch, whose head must be screwed on and locked.

5.4 Explosion-proof pneumatic crossings

The pneumatic crossings allowing the gas inlets and outlets of the main enclosure are certified assemblies. For this reason, they must not be dismantled by unauthorized personnel or used for external applications. These crossings have a specific marking for their traceability.

Typically, fittings on pneumatic crossings are made with 1/8" O.D. stainless steel tubing via 1/4" ISO - 1/8" Swagelok® male conical housing fittings (part number SS-200-1-4RT).

5.5 Electrical connections

All connections must be made in accordance with EN 60079-14.

Electrical connections must be made **OFF VOLTAGE** after the analyzer has been mounted and secured. Wiring will be carried out in accordance with the code of practice and standards in force. The cables used must be perfectly adapted to the cable entries supplied.

To ensure a perfect seal, it is advisable to tighten the cable gland with a suitable wrench. The connection blocks are provided for wires up to 1.5 mm² for the certified junction box with the analyzer (RS485 connection and external control valves) and for 2.5 mm² wires for the main switch supply.

The individual components are connected to a ground terminal on the analyzer frame, which must be connected to a ground circuit.

The enclosure casing must be earthed by a cable with a cross-section greater than 4 mm².

The nature and installation of the cables must comply with the standards in force. Every precaution must be taken to avoid electromagnetic coupling with other cables.

The cables and wires must be protected against damage.

The protection of the 220 V line (good amperage, circuit breaker) is the responsibility of the customer.

5.6 Recommendation for cable glands supplied

The use of certified EEx d cable glands is mandatory. The IP protection rating must be at least equivalent to that of explosion-proof enclosures.

The 1/2" NPT cable glands on the explosion-proof enclosures and power switch comply with the following classifications:



Reference	Thread	Outer sheath of the cable	Marking	Certification
REV1NB	1/2" NPT	7-12 mm	0722 Ex II 2 GD - Ex d IIC Gb Ex tb IIIC Db - IP66/67	ATEX CESI 13 ATEX 019 X
REVL1NB	1/2" NPT	5-10 mm	0722 Ex II 2 GD - Ex d IIC Gb Ex tb IIIC Db - IP66/67	ATEX CESI 13 ATEX 019 X
REVDL1NB	1/2" NPT	8-15 mm	0722 Ex II 2 GD - Ex d IIC Gb Ex tb IIIC Db - IP66/67	ATEX CESI 13 ATEX 019 X

When there is no cable gland or feed-through mounted on one of the openings of the enclosure, the following plugs, in conformity with the regulations, are installed.

These are male plugs with conical thread:

Reference	Thread	Marking	Certification
PLG1NG	1/2" NPT	0722 Ex II 2 GD - Ex db IIC Gb Ex tb IIIC Db - IP66/67 0722 Ex II 2 GD - Ex eb IIC Gb Ex tb IIIC Db - IP66/67	ATEX CESI 02 ATEX 049X

6. Starting up

6.1 The 4 golden rules

MicroGC technology is easy to use. No chemical or analytical knowledge is required for basic use and setup. However, as with any analysis instrument, there are important rules to follow to protect your instrument and its functionality.

These rules can be presented as "the 4 golden rules":

- Carrier gas pressure
- Carrier gas quality
- Sample pressure
- Sample quality



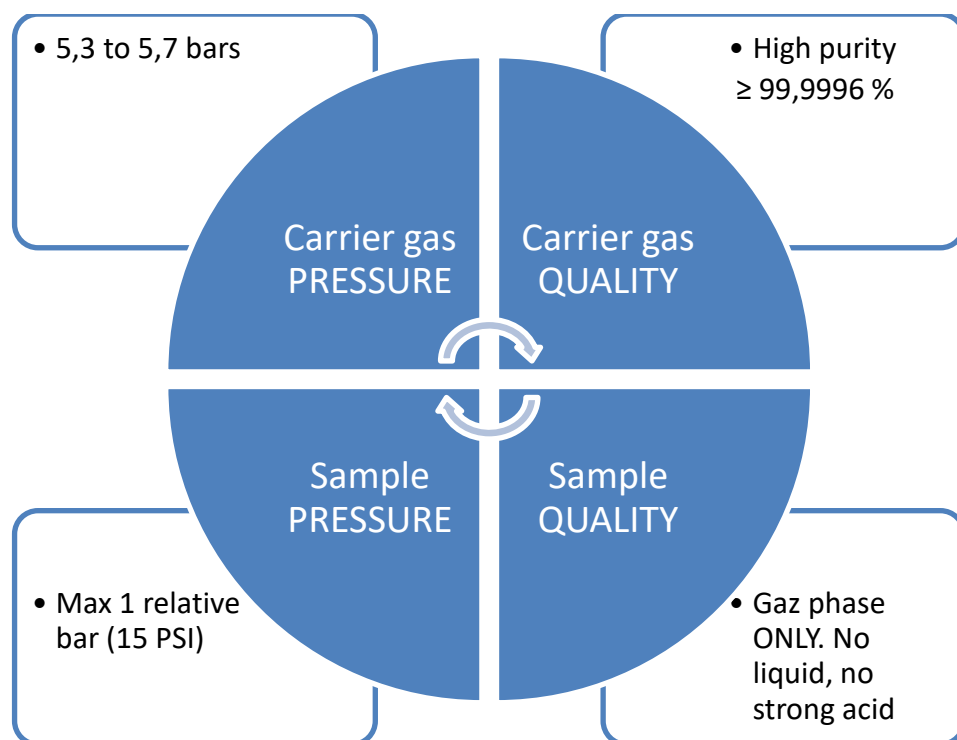

Not respecting these rules highly increases the risk of damaging your instrument. All standard procedures for using MicroGC are derived from these 4 golden rules: the quality of the carrier gas will require a tube purge to ensure this level of quality.

6.2 Carrier gas connection

Your analyzer has been factory configured with helium as the carrier gas to perform the verification method. If you choose to use another carrier gas, first install the instrument and check the performance described here, then reconfigure your instrument according to the instructions.

Your instrument can have 2 carrier gas inlets. This offers the possibility to use different carrier gases on different modules. Argon is usually used on MS5Å columns to detect and quantify He under the best conditions.

In a standard instrument, module A is supplied by carrier gas 1 and modules B and C by carrier gas 2.

If you wish to use only one type of carrier gas, you can use a brass or stainless-steel T-connector.

After selecting the carrier gas assignment and type, you can connect the carrier gas according to the following steps:

- Purge the air in the pressure gauge and tubes correctly.
- Set the pressure to 5.6 bar +/- 0.2 bar.
- Underflow, connect the tube to the carrier gas inlet.



Important:

The use of helium as a carrier gas with the MicroGC configured for Ar/N₂ will decrease the detector sensitivity (about 10 times), invert peaks, without any other incidence.



Using argon as a carrier gas with the MicroGC configured for He will destroy the TCD filaments.

The carrier gas must circulate before the analyzer is switched on.

6.3 Typical MicroGC Sample lines

WARNING

The sample must be clean and dry. Although the internal filter removes many particulate contaminants, samples containing aerosols, excessive amounts of particulate matter, high water concentrations and other contaminants can damage your instrument. The presence of acids (HF, HCl, H₂SO₄ and HNO₃) is prohibited.

The inlet pressure of the sample must be less than 2 bars and its temperature must not exceed 100 °C.

Sampling modes

You will need suitable mounting equipment to connect the sample to the PGC or an accessory.

Several sampling modes can be used with the MicroGC. Samples are usually in gaseous form, but it is also possible to analyze liquefied gases (LPG).

Priority should be given to the sample pressure: *positive pressure sample or atmospheric pressure sample*. Sampling and conditioning are essential for good analysis and correct results. It is important to study this part as well as possible. In what follows, we report some examples of traditional packaging and sampling that can be used by the MicroGC.

Positive pressure sample

The best solution is to use a fast loop not far from the MicroGC and at a pressure as close to atmospheric pressure as possible. This method gives better results than a direct connection of the sample to the MicroGC input.

It is recommended to use a MicroGC bypass filter (Genie Filter) that can filter the sample to 0.5 micron and protect the MicroGC from liquids and aerosols.

When calibrating, simply connect the calibration mixture instead of your sample.



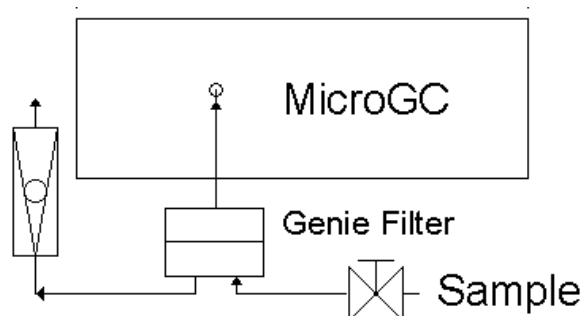

If there is a risk of condensation of the sample (organic solvents or high-boiling compounds), it is preferable to choose the same system installed in a heated and insulated box.

If you need to work under pressure, always keep in mind that your sample and calibration gas must have the same pressure.

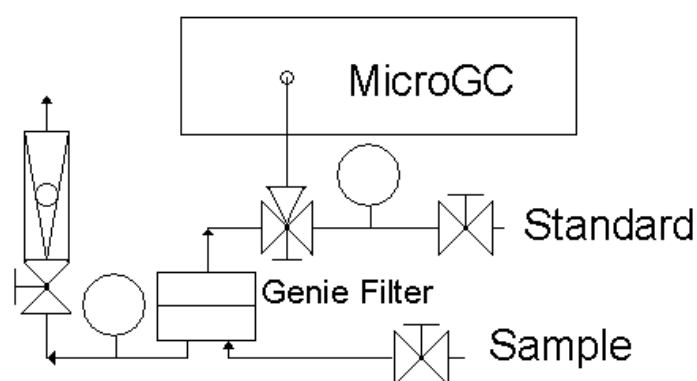

In the figure above, the standard and sample are connected to a 3-way valve that can be automated. The sample is still circulating but the standard is retained and used only for calibration.

This type of system can be heated and insulated.

Sample at atmospheric pressure

- Atmospheric air: (ex: online air pollution control), you can add a circulation pump to the bypass filter outlet.
- Tedlar bags: you can fit a syringe needle on the sample inlet of the analyzer, the outgoing needle will be placed in the septum of the bag that will be presented.
- Container with septum: same possibilities as with Tedlar bag, but in this case, you can only make a few injections, because then the pressure will decrease.



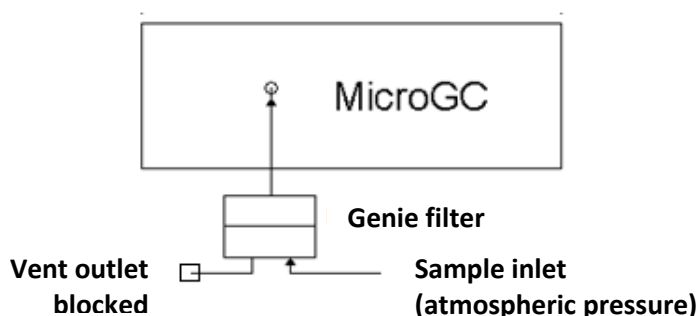

6.4 Sample release outlets

In the case of the use of 2 different carrier gases (Argon & Helium), we recommend that you do not group the outlets together. Different types of carrier gases must have different exhausts. Leave these outputs at a constant (almost) atmospheric pressure to avoid "peaks" on the TCD signal.

7. Start-up procedure

The start-up procedure includes the various steps presented in the paragraphs below.

7.1 Start-up the chromatograph

After connecting and supplying the PGC with carrier gas, switch on the instrument.

Even if the analyzer is switched off, the carrier gas flows through the instrument. It takes about 3 minutes for the analyzer to purge before it can communicate.

7.2 Launch the software

For this, refer to the specific PGC 490 manual.

7.3 Load the PURGE method

When you turn the MicroGC on, it will load the last method used before turning the instrument off.

The entire internal pneumatic circuit contains air. If you correctly followed the procedure to connect the carrier gas to the instrument, you purged the external tubing and connection. It is now necessary to purge internal manifolds, regulators and column by loading a « purge » method.

For each module, load a method of this type:

- Injector: 30 °C
- Column: 30 °C
- Pressure: 30 PSI
- **Detector: OFF**



Other parameters have no incidence because no analysis will be done with this method.

The carrier gas is now circulating and purging the whole system including the detector.

Let the MicroGC purge during approximately 10 minutes.

7.4 Load the ANALYSIS method

After the purge time, you can load safely the « analysis » method. After the method load, the analyser will be ready to inject and analyse the sample.

The table below gives limits and average values for a first use of your MicroGC. These values are given as an indication and must be modified for the optimization of your analysis method.

	ZONE	MIN	MAX	MEAN VALUE	COMMENT
TEMPÉRATURE (°C)	Sample inlet	30	140	90	Optional heater for permanent gas analysis
	Injector	30	100	90	Optional heater for permanent gas analysis
	Column	30	180	90	For several columns, maximum temperature of 160°C only
PRESSURE (PSI)	Column head pressure	18	50	30	Except in specific cases, it is recommended not to work above 35 PSI.
TIME (MS)	Injection time	50	300	100	Variable volume injector
	Injection time	50	300	50	Backflush injector
TIME (S)	Backflush time	-	-	To adjust	Optional, for backflush injector. The BF time must be adapted to the specific parameters of your method.
	Sampling time	5	60	15	The suction flow rate is 5 to 8 cc/mn. The duration depends on the sample
	Run time	20	600	180	
STATE	Detector gain	Low	Extra high	Auto	High sensitivity reduces noise. It is used for trace analysis. The Auto mode can be used to automatically adjust the different sensitivities during the analysis.

8. Stop procedure

SRA INSTRUMENTS
210 rue des Sources
69280 Marcy l'Etoile
FRANCE

T : 04.78.44.29.47
F : 04.78.44.29.62
info@sra-instruments.com
www.sra-instruments.com

SA à Directoire et Conseil de surveillance au capital de 150.000 €
RCS Lyon B 342 068 731
APE 4669B
SIRET: 342 068 731 00054
Code TVA FR 40342068731



There are different possibilities for which you will need to stop your PGC 490:

- Short time stops (less than 2 weeks)
- Long stops (more than 2 weeks) or when you need to move the chromatograph in another place.

8.1 Short time stops (less than 2 weeks)

To maintain peak operating performance, we recommend that you let the instrument turned on with carrier gas flowing through the system.

To do this, create a method that:

- Turns off the detector filament
- Maintains a small carrier gas purge flow through the system
- Lowers the column temperature

8.2 Long stops (more than 2 weeks) or PGC moving

To shut down the PGC 490:

1. Load a method with these parameters:
 - Injector: OFF
 - Column: OFF
 - Pressure: 30 PSI
 - Detector: OFF
2. Wait until the column temperature is below 60 °C
3. Turn off the power and unplug any accessory power cord.
4. When the analyzer is switched off, the carrier gas always flows in the columns; you can then close the carrier gas supply.

These procedures help prevent column contamination and degradation.

9. Maintenance

Maintenance must be carried out in compliance with standards:

- **NF EN 60079-17** (Explosive atmospheres - Part 17: Inspection and maintenance of electrical installations)
- **NF EN 60079-19** (Explosive atmospheres - Part 19: Repair, overhaul and refurbishing of the apparatus).

Caution to be observed during the servicing:

Any intervention inside the explosion-proof enclosures, or any disassembly, must be carried out **OFF VOLTAGE** and after verification of the **DANGEROUS ATMOSPHERE ABSENCE**.

This work may only be carried out by qualified personnel (ATEX 2). The power supply can be switched off either by the explosion-proof switch of the analyzer in the event of brief intervention, or by the general power supply, upstream of the switch, during intervention for dismantling or moving the analyzer.



Any intervention in the analyzer, by personnel not competent or without the authorization of SRA Instruments, will exonerate SRA Instruments, in case of failure.

In case of malfunction or breakdown, the equipment must be returned to our services, which alone are authorized to carry out an expertise or repair.

It is totally forbidden for the user to intervene in any way whatsoever on the electronic cards.

Column bake out

If the analyzer has not been used for a long period of time and the carrier gas circulation has been stopped, the fact that the column outlet remains in contact with the atmospheric air results in a more or less important air intake. This air intake is accompanied by the introduction of CO₂ and humidity, which leads to a change in the column's separation capacity.

A similar degradation can also occur in normal operation due to the increase in moisture content in the carrier gas (as the cylinder empties), but also by entering moisture traces on the sample or the carrier gas transfer line.

Column regeneration is part of the normal maintenance of your MicroGC. In extreme cases, oxygen and nitrogen can no longer be separated.

Regeneration consists of downloading the following method for 24 to 48 hours:

- Sample input: OFF
- Injector heating: OFF
- Column heating: maximum temperature
- Carrier gas pressure: 30 PSI (approx. 2 bar)
- Detector: OFF

The columns on which the bake out is significant and even necessary are:

MS5A	180°C
PPU	160°C
PPQ	160°C
Al ₂ O ₃	180°C

All other columns can also be regenerated at the maximum temperature.

On modules equipped with a "backflush" injector, and thus with a pre-column, it is the column temperature which has the smallest limit value which is applied.

If you have a "backflush" injector in a module, the good "backflush" time setting will allow you to decrease the bake out frequency.

To regenerate columns, simply download the regeneration method.

Once the regeneration method is loaded into the analyzer:



Check that the detector is OFF, that the temperature of the columns reaches 160 or 180 ° C and that the device is stabilized at this temperature.

Maintain these regeneration conditions for a full night or even a weekend if possible. The maximum recommended regeneration time is 48 hours.

At the end of regeneration:

Download the method to be used into the analyzer and wait 10-15 minutes until the temperatures indicated in the method are reached and the analyzer is stabilized. Then, perform calibration gas analyses to check if it is necessary to correct certain parameters (integration and/or identification). If this is the case, consult the Soprane documentation to correct the parameters.

It is often that retention time is moved after a bake out.

10. Technical data

SRA INSTRUMENTS
210 rue des Sources
69280 Marcy l'Etoile
FRANCE

T : 04.78.44.29.47
F : 04.78.44.29.62
info@sra-instruments.com
www.sra-instruments.com

SA à Directoire et Conseil de
surveillance au capital de 150.000 €
RCS Lyon B 342 068 731
APE 4669B
SIRET: 342 068 731 00054
Code TVA FR 40342068731



10.1 Power supply

Power supply input: 220 - 240 VAC, 50 to 60 Hz

Power consumption: 10 A maximum

10.2 Dimensions and weight

Dimensions (mm): H 500 ; D 262 ; W 465

Weight: 45 kg

10.3 Chromatographic modules

- Up to 3 modules
- 1 or 2 carrier gases
- Up to 2 independent internal sampling pumps

10.3.1 Carrier gases

- Compatible with helium, hydrogen, nitrogen, and argon with 1/8" Swagelok fittings.
- Inlet pressure: minimum = 550 ± 20 Kpa (80 ± 3 psi) 5.5 bars
- Minimum purity: 99,9996 %

10.3.2 Sample and injection

- Gas or vapor samples only
- Sample pressure: from atmosphere to 14,5 psi max (1 bar)

10.3.3 Injector

- Injector type: Micro-machined injector with no moving parts ; variable volume ; optional: heated injector and backflush capabilities.
- Injection volume: 1 to 10 μ L, software-selectable.

10.3.4 Column

- Column: capillary fused silica column from 200 μ m to 320 μ m, stationary phase depending on the application.
- Column temperature: isothermal operation, ambient +15 °C to 180 °C.

10.3.5 Detector

- Detector: Micro-machined thermal conductivity detector (μ TCD) using Wheatstone bridge design (internal volume 200 nL).

10.3.6 Linear dynamic range

- 10^6 for most of the compounds

10.3.7 Repeatability

< 0,5 % RSD for propane at 1 mol % level for WCOT columns at constant temperature and pressure.



10.4 Communication

Ethernet with possibility of an embedded computer.

10.5 Inputs/Outputs

Outputs : configurable relay outputs.

Optional analog signals : 4-20 mA inputs/outputs.

Digital inputs : 0 - 10 V, external start, sampling default (optional) etc...

10.6 Driving software

Acquisition and processing software : Soprane

Operating system : Windows 7 - 32/64bits or higher.

Modbus (Ethernet / RS) : configurable.

10.7 Specific calculation

Option : NGA/RGA ISO-6976, LPG ISO 8973/7941/6578, combustion gas, customized.



11. EU declaration of conformity

We,



INSTRUMENTS
CHROMATOGRAPHIC SOLUTIONS

SRA Instruments
210 Rue des Sources
69280 MARCY L'ETOILE
FRANCE

As a manufacturer, declare under our sole responsibility that the instrument type

PGC 490 - Explosion-proof MicroGC analyzer CE 0081  II 2 G - Ex db IIC T5 Gb -40°C ≤ ambient temperature ≤ +55°C	
--	---

to which this declaration relates, meets the Essential Health and Safety Requirements applicable to it and which are defined by the following Directives and subsequent additions and / or changes:

- 1/ Directive 2014/35/EU, Annex I
- 2/ Directive 2014/30/EU, Annex I
- 3/ Directive 2014/34/EU, Annex II

Compliance with the above requirements has been ensured by applying the following standards:

1/ Directive 2014/35/EU – Low voltage

- EN 61010-1:2010 "Safety requirements for electrical equipment for measurement, control, and laboratory use – Part 1: General requirements"
- EN 61010-2-081:2015 "Safety requirements for electrical equipment for measurement, control and laboratory use – Part 2-081: Particular requirements for automatic and semi-automatic laboratory equipment for analysis and other"

2/ Directive 2014/30/EU – Electromagnetic compatibility

- EN 61326-1:2013 " Electrical equipment for measurement, control and laboratory use – EMC requirements – Part 1: General requirements"
- NF-EN 61000-4-2:2009-06 " Electromagnetic compatibility (EMC) – Part 4-2: Testing and measurement techniques – Electrostatic discharge immunity test"

3/ Directive 2014/34/EU – Equipment and protective systems intended for use in potentially explosive atmospheres

- EN 60079-0:2012 + A11:2013 "Explosive atmospheres - Part 0: Equipment – General requirements"
- EN 60079-1:2014 "Explosive atmospheres - Part 1: Equipment protection by flameproof enclosures "d" "

In accordance with Directive 2014/34/EU (Annex III - Module B), the above-mentioned equipment is subject to an *EU-type examination certificate*:

LCIE 17 ATEX 3064 X
Notified Body N°0081

Laboratoire Central des Industries Electriques
33, avenue du Général Leclerc, BP8
92266 FONTENAY AUX ROSES Cedex FRANCE

In accordance with the same Directive (Annex VII - Module E), but relating to production aspects, the above-mentioned equipment is subject to the *quality assurance notification* issued by the same Notified Body:

LCIE 16 ATEX Q 7002

In accordance with the other directives mentioned above (Module A), the above-mentioned equipment is subject, regarding design and production aspects, to *internal production control*: **EX E FAB 08**

Marcy l'Etoile, 07 August 2018

Legal representative,
Luigi COBELLI

LUIGI COBELLI

210 rue des Sources
69280 MARCY L'ETOILE
Tél. 04.78.44.29.47
Fax 04.78.44.29.62
www.sra-instruments.com
SIRET: 342 068 731 00054

SRA INSTRUMENTS
210 rue des Sources
69280 Marcy l'Etoile
FRANCE

T : 04.78.44.29.47
F : 04.78.44.29.62
info@sra-instruments.com
www.sra-instruments.com

SA à Directoire et Conseil de
surveillance au capital de 150.000 €
RCS Lyon B 342 068 731
APE 4669B
SIRET: 342 068 731 00054
Code TVA FR 40342068731